

Cleco® D&D

DC Electric Assembly Tools



Safety Critical



Quality Critical



Fixtured Safety Critical



Controllers



Accessories



Introduction 2-3
 Product Descriptions 4-25

Building A Safety Critical DC Fastening System 26

Cordless Transducer Control Tools 28
 Right Angle Tools 28
 Pistol Tools 29
 Tube Nut Tools 30
 Crowfoot Tools 31

Corded Transducer Control Tools 32
 Right Angle Tools 32
 Inline Tools 34
 Pistol Tools 36
 Push-to-Start Tools 37
 Inline Floating Spindle Tools 38
 Hold & Drive Tools 40
 Flush Socket Tools 41
 Tube Nut Tools 42
 Crowfoot Tools 43
 Right Angle Floating Spindle Tools 44

Building A Quality Critical DC Fastening System 46

Corded Current Control Tools 48
 Right Angle Tools 48
 Inline Tools 49
 Pistol Tools 50
 Push-to-Start Tools 51
 Inline Floating Spindle Tools 52
 Hold & Drive Tools 53
 Flush Socket Tools 54
 Tube Nut Tools 55
 Right Angle Floating Spindle Tools 56
 Crowfoot Tools 58

Building A Safety Critical Fixtured DC Fastening System 60

Fixtured Transducer Control Tools 62
 Intelligent Spindles 62
 Intelligent Spindle Accessories 88
 Conventional Fixtured Spindles 90
 Conventional Fixtured Spindle Accessories 112

Controllers 114
 mPro400GC-M, -P, -S, -SG Panel Controllers 114
 mPro400GC-E, -I Controllers 115
 mPro400SG Controllers 116
 Software 119

Accessories 121
 Isolation Transformer 121
 Tool Cables 122
 Cordless Tool Accessories 123
 Corded Tool Accessories 124
 Balance Arms & Balancers 128

General Accessories & Information .. 130
 Apex Bits & Sockets 132
 Conversion Charts 134
 Model Number Index 137
 Warranty & Lubrication 140

The Total Solution For Safety & Quality Critical Fastening Operations

Cleco's fastening technology is used globally and across all industries. This technology is used in Aerospace, Motor Vehicle, Offroad, Wind Energy, Agriculture, and a great multitude of applications within general industry where "quality critical" requirements are the rule. In motor vehicle environments across the globe, Cleco and DGD's complete line of transducerized electric tools are used in "safety critical" applications where spot-on precision and traceability are required. And finally, in one of the most demanding environments, our line of DC electric tools are used in aircraft assembly where "good enough" will never be acceptable.

Because of our drive for perfection, you can excel in your job. Indeed, due to our uncommon focus on

total fastening solutions instead of just products, our customers look upon us not merely as vendors, but as strategic allies. And at Apex, we welcome the challenge of leadership this imposes.

The Systems

Cleco's state of the art Tightening System delivers unprecedented performance, productivity and accountability in both "quality critical" and "safety critical" assembly applications.

Durability, speed, and ergonomics are achieved using the corded Cleco DC electric tools with a complete line of tool configurations and an assortment of controller options to choose from.

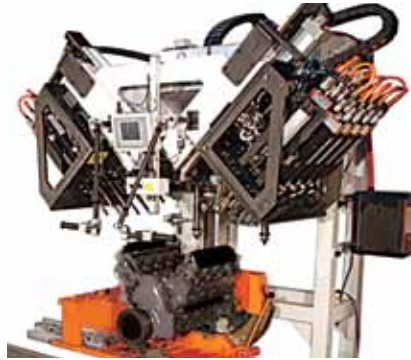

The Cleco LiveWire™ system provides the most cost-effective safety critical fastening solution available in the world today. By marrying cordless tools and WiFi communications, the operators gain the mobility and flexibility they need to increase productivity and reduce in-system damage costs. One line controller managing up to 16 cordless tools while utilizing the most up-to-date wireless encryption technology provides a cost savings unparalleled in industry today.

When considering the cumulative impact of all these components – the tools, the controllers, the software, the flexibility, the accessories and the support – it is easy to see why the Cleco Tightening System is the benchmark for all DC electric tool systems.

Application Segment

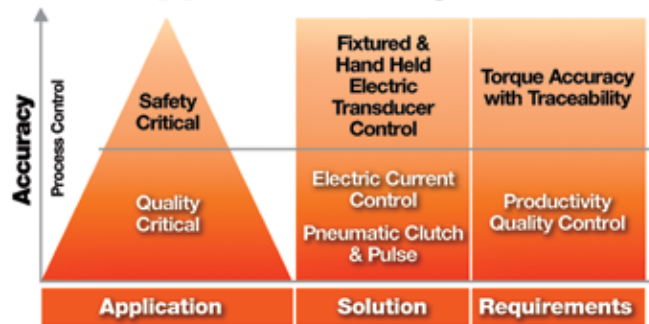

Cleco®



The Most Flexible, Cost-Effective

Introducing the Cleco **mPro400GC** Global Controller, the first controller for safety-critical applications that offers unsurpassed levels of flexibility, connectivity, and serviceability while providing superb torque accuracy and process control. This new controller incorporates the advanced technical features of the proven DGD mPro system with the user-friendly software of the trusted Cleco TME controller, resulting in a powerful control solution that offers impressive cost savings through unequalled flexibility.

Corded, Cordless, Or Fixtured ... All From One Controller

The Cleco **mPro400GC** Global Controller is compatible with all Cleco 18-48 Series DC electric corded tools, LiveWire cordless tools, and all DGD and EMT fixtured spindles. That means fewer controllers and cables are needed for your line. And that means savings...up to 50% over traditional systems.

Reduce System Costs Up To 50%

- Configure up to 32 DC spindles in varying configurations. Consult your Apex representative for details.
- **Facility Cost Savings**
 - Installation Expenses: Save on Ethernet and power drops, controller stands, cable management, labor to install and support
 - Production Expenses: One controller means fewer backups, fewer repairs, fewer headaches and one-time training



Intelligent Systems Controller... Ever

Control System



Data Server
TorqueNet



mPro Remote
Programming



Access
Point



CPM3 system with
internal power
transformer



DGD Intelligent Spindles
Unique Technology, Smallest Hardware Foot Print, Best TCO.



Customer
Control
System



DGD
Conventional
Spindles



Corded Hand Tool



LIVewire™



**LIVewire
vmax**



Universal Connectivity

Universal connectivity begins with global auto-sensing input voltage, 16 configurable inputs and outputs, plus DeviceNet, Ethernet-IP, Profibus and Profinet fieldbus standards. User-friendly software mapping of discrete and fieldbus selections provides ultimate error-proofing control. Dual fieldbus ports allow redundant I/O mapping or expansion. Utilize two different fieldbus standards simultaneously for maximum flexibility.

The Cleco **mPro400GC** Global Controller comes standard with a system bus to manage internal data flow and avoid burdening outside networks. It can be utilized for rapid “grab and go” connectivity to accessories, such as adding error-proofing

from socket trays, stack lights, or operator boxes. Configurable software menus allow quick integration into any process. With up to 32 configurable nodes on the system bus, endless error-proofing combinations are possible.

The system bus can manage multiple secondary controllers in combination with single and multi-spindle stations. Spindle sequencing, data management, and diagnostics are just a few of the many functions performed. In addition, DGD® Fixtured Intelligent Spindles can utilize the system bus to drive up to 30% of cost out of a traditional system through cable reduction, maximizing acquisition and facility cost savings.

Universal Connectivity

- Auto-Sensing Voltage
- 16 Configurable I/O's
- Redundant Fieldbus
- Redundant Serial and Ethernet Ports
- Isolated System Bus

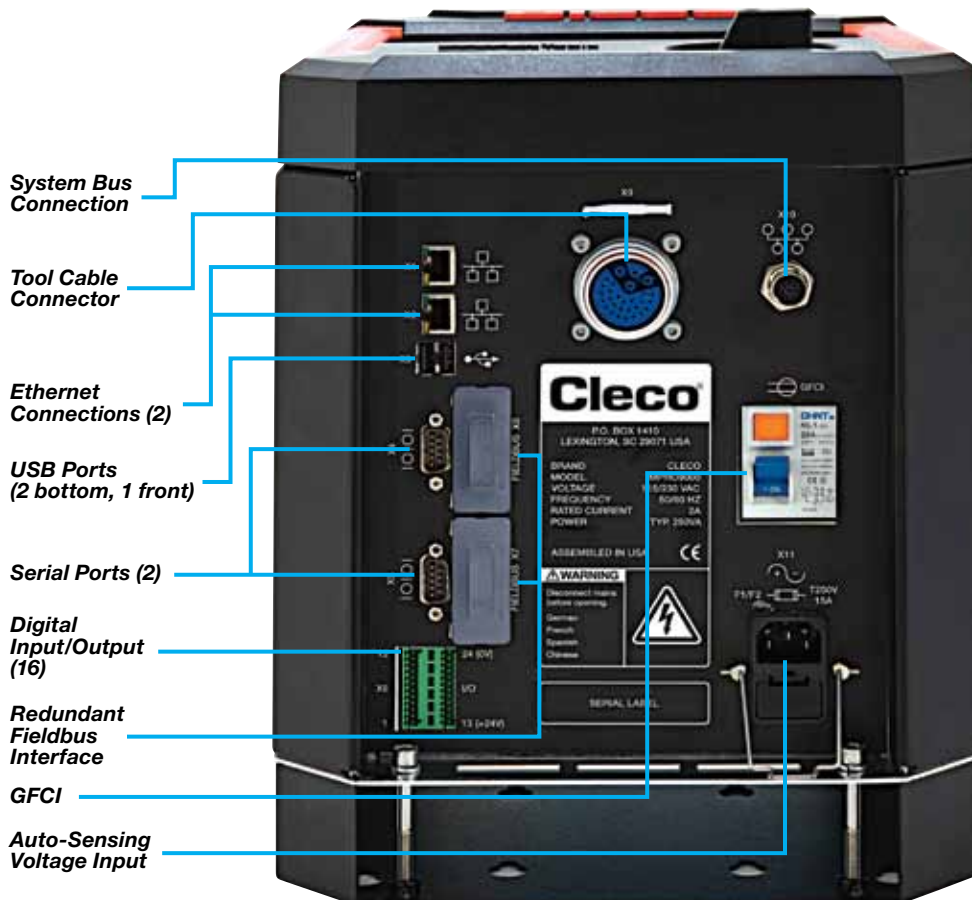

For Ultimate Flexibility

Rundown Data Storage

The **mPro400GC** supports TorqueNet, our data collection and archiving software, as well as other industry standard software packages. Protocols are available for many of the standard products.

The Cleco **mPro400GC** Global Controller works seamlessly with current protocols and offers significant performance advantages over traditional systems. Features include:

- A single software program that covers both standard and fixtured applications
- Standard spindle sequencing and reject management
- 19 advanced fastening control sequences standard at no additional cost
- Remote programming software with no licensing restrictions
- Touch screen display with integrated alpha-numeric keyboard

No Software Licensing!



User Friendly GUI



Oscilloscope Process Management

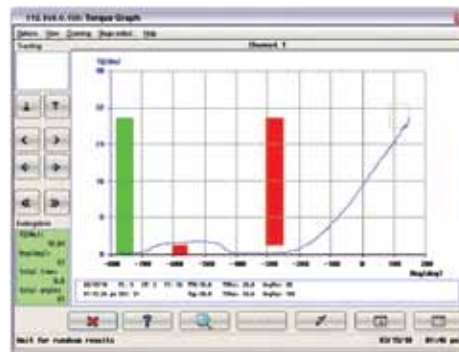

Quick-Start Auto Program Option

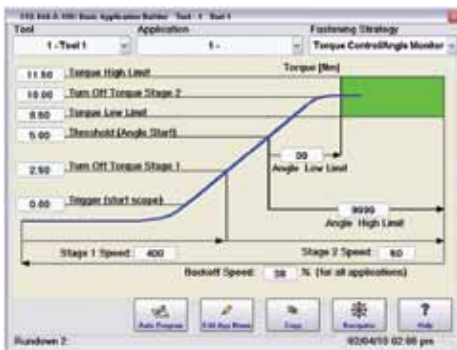

In-Depth Data Management

Run No.	Pos	S	Z	Start	Meas	Stop	Error	Rate	Time	Markings
1	1	1	1	1	1	1	1	1	1	1
2	1	1	1	1	1	1	1	1	1	1
3	1	1	1	1	1	1	1	1	1	1
4	1	1	1	1	1	1	1	1	1	1
5	1	1	1	1	1	1	1	1	1	1
6	1	1	1	1	1	1	1	1	1	1
7	1	1	1	1	1	1	1	1	1	1
8	1	1	1	1	1	1	1	1	1	1
9	1	1	1	1	1	1	1	1	1	1
10	1	1	1	1	1	1	1	1	1	1
11	1	1	1	1	1	1	1	1	1	1
12	1	1	1	1	1	1	1	1	1	1
13	1	1	1	1	1	1	1	1	1	1
14	1	1	1	1	1	1	1	1	1	1
15	1	1	1	1	1	1	1	1	1	1
16	1	1	1	1	1	1	1	1	1	1
17	1	1	1	1	1	1	1	1	1	1
18	1	1	1	1	1	1	1	1	1	1
19	1	1	1	1	1	1	1	1	1	1
20	1	1	1	1	1	1	1	1	1	1

Easy-To-Read Run Screen



Digital Image Bolt Sequencing

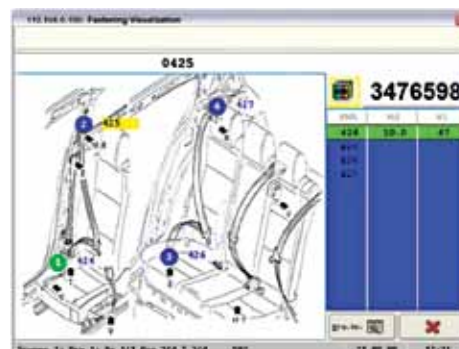

Superior Serviceability For



Installation Flexibility

At only 10" w X 15" h X 15" d (254mm X 381mm X 381mm) and weighing just 30 lbs. (13.6 kg.), the Cleco **mPro400GC** is smaller and lighter than most traditional controllers. It can be lifted easily by a single person and will mount just about anywhere.



Exceptional Ease-Of-Use

Quick Mount Bracket

No more templates and measuring mounting hole patterns...installation of the **mPro400GC** is simple with a separate receiver bracket that makes locating mounting holes easy. The unit then attaches directly to the bracket so the installation is fast and foolproof.

Integrated Cable Management

The **mPro400GC** mounting bracket incorporates an integral cable management channel, so installations stay orderly and easily accessible. Clearly labeled connectors and top-down cable routing means a clean installation with no guesswork. Mounting was designed to be simple and effective to get you up and running fast.

CompactFlash® Memory For Production Uptime

A standard CompactFlash card reliably stores:

- Operating system
- Drivers
- Network settings
- Application parameters
- Torque data

**50
Second
Boot!**

Positioned on the back of the unit for added security and tamper resistance, the card is still easily accessible.

- Rapid controller swap with 50-second boot
- No licensing or proprietary hardware
- Card stores up to 10,000 rundowns

Secondary Controller Functionality

A secondary controller is controlled from a master or primary unit. It has I/O for local error proofing and peripherals, plus a LCD for operator feedback and troubleshooting.



All The Brains. All The Power.

LiveWire™ offers precision torque, angle and speed control features for safety critical fastening in an ergonomic, wireless design.

With up to 1,700 rundowns per battery charge or continuous power, your safety critical applications are assured to never run out of power.

LiveWire™ has been designed and tested to provide wireless connectivity across the harshest of machine-to-machine environments.

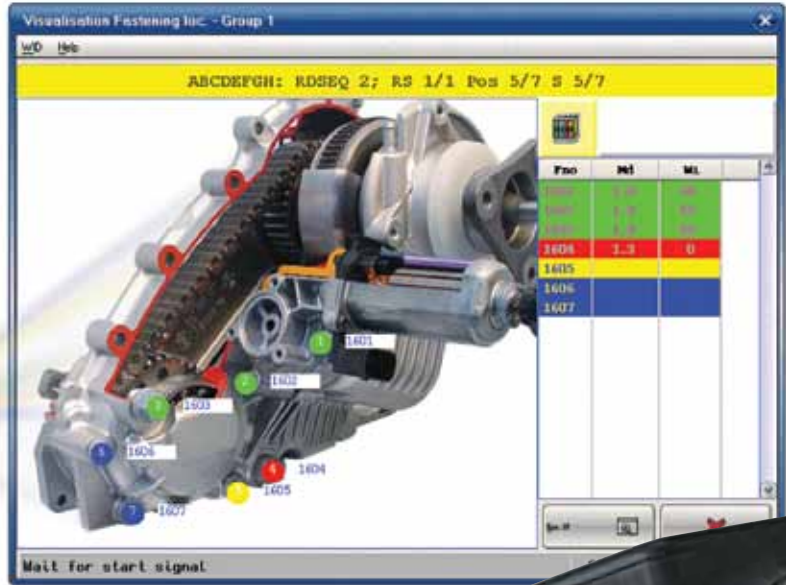

Digital Process Control

- Auto bolt sequencing
- Auto image selection
- Configurable reject management



Electronic Intelligence

- On-board controller with power management
- Integrated servo with I/O signal handling
- Auto sensing power intelligence
- 512 cycle memory buffer



Power. And It's Wireless.

Integrated Bar Code Scanner (optional)

- Enables real-time bar code data collection
- Programmable bit for Auto Parameter Select
- Tool enable and disable configurability



Operator Display

- Real-time interface
- Redundant feedback
 - Green LCD = OK
 - Yellow LCD = Running
 - Red LCD = NOK / Errors
 - Green LED = OK
 - Red LED = NOK
- Configurable application buttons



The Most Cost-Effective Safe

Up To 50% Savings Over Traditional Systems!

Mobility is a major advantage with wireless communications. Cleco LiveWire™ marries the freedom and flexibility of cordless tools with real-time wireless error proofing. Utilizing an industry standard 2.4/5GHz WLAN (Wireless Local Area Network) interface in conjunction with the highest security encryption and authentication levels, plus a 512-cycle tool memory buffer, LiveWire™ ensures you will never compromise safety critical data transmissions.



**Up To 16
LiveWire
Tools.*
1 Line
Controller.**

*Contact Regional Application Center for requirements greater than 10.

**2.4 or
5GHz
WLAN**



Security Critical Solution Available

Up To 83% More Productivity!

Cleco LiveWire™ tools are now available with Vmax™, a solution that drives tool power and speed increases up to 83% without losing accuracy or durability. This leading innovation utilizes the same 10 tools to one line controller hardware solution with up to 50% cost savings over traditional systems. New Vmax™ technology auto-senses the applied power source and adjusts the maximum tool speed capability on the fly. LiveWire™ with Vmax™ combines the power you need with the most versatile wireless system available today.

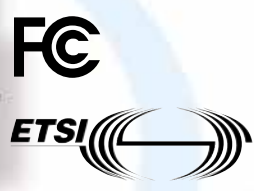

Wireless Security

- WEP (Wired Equivalent Privacy)
 - 64/128 Bit Encryption
- WPA (Wireless Protected Access)/WPA2/802.1x
 - 128 Bit TKIP/CCMP Encryption
 - 802.1x Authentication pre-shared keymode (PSK) - LEAP, PEAP



Durability. Speed.

Cleco 18-48 series tools are driven by a maintenance-free brushless motor with up to 50% more speed and productivity. This motor technology coupled with our high-resolution resolver offers full range control for safety critical joints. The 18-48 series tools with industry proven gear trains create outstanding durable production performance.

The Cleco 18-48 series electric tools provide a unique modular assembly design for ease of repair. The on-board intelligent memory chip records tool set-up values and counts cycles for maintenance scheduling to prevent costly production downtime.

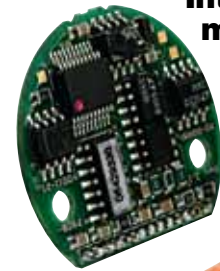

Intelligent memory chip

Highly visible operator feedback LEDs

Error free connector

(in tool handle)



Air-LB

(Tools with Matrix connector available upon request.)

Low compression switch



Ergonomic handle for operator comfort



Resolver technology for full range speed control



Ergonomics.

Optimal tool weight and balance

Durable industry proven gear train

Reaction transducer for consistent torque repeatability

Adjustable angle head allows flexible orientation

Low inertia brushless motor for superior fastening control

Standard tools required for service



Durability. Speed

Cost Effective Solution for Quality Critical Applications.

Cleco **CurrentControl** electric assembly tools provide an up-sell solution to quality critical applications presently specifying a pneumatic clutch tool and verifier combination. Cleco proprietary **CurrentControl** systems up-sell on superior productivity, error proofing and process flexibility.

Our Cleco controller systems are recognized globally for “best in class” software interface. This is accomplished through simple navigation, basic programming screens, visual programming graphics and real-time process feedback. Our latest innovation “Auto Program” takes the guesswork out of programming. Simply enter the application torque target and the software automatically compiles the program for production use.



Unrestricted Speed Control



Adjustable angle head allows flexible orientation

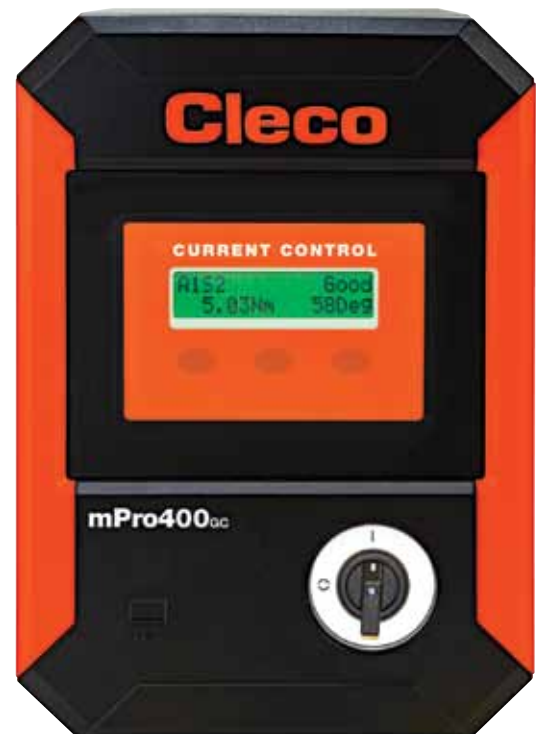

Cleco[®]

ed. Ergonomics.

Why CurrentControl vs. Pneumatic Clutch?

Superior Productivity

- Up to 2–3X faster
- Unrestricted speed control
- Up to 25% less noise
- Cleaner operating environment
- Auto torque sequencing
- Proven production durability

Superior Error Proofing

- 96 position fastener count
- 9 tool LED operator feedback
- 8 configurable I/O
- Fieldbus ready
- 5,000 tightening cycle storage
- Advanced system diagnostics
- Barcode application select

Superior Process Flexibility

- 255 programmable tightening strategies
- 6 configurable stages per strategy
- Angle process control/monitoring
- Counter-clockwise process control/monitoring
- Less parts to maintain – no clutch
- 100M field cable lengths

Easy Setup 1-2-3-Go!

1. Select "Basic" from menu.



2. Enter final torque value.

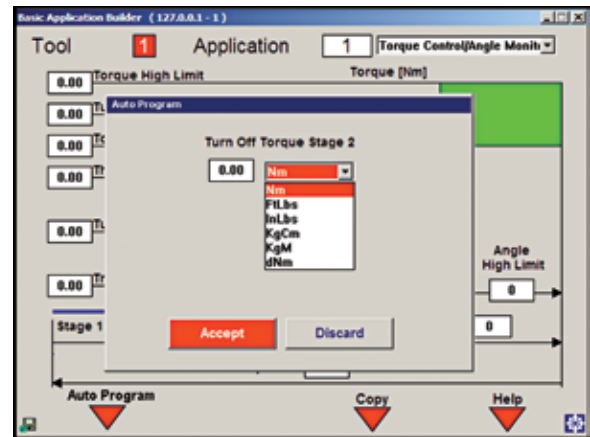

3. Tool automatically programmed.

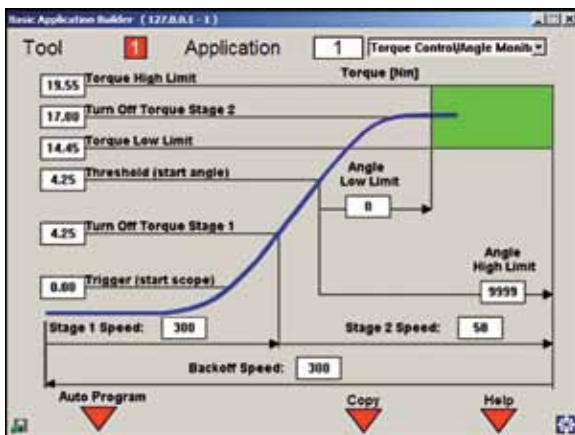

Go! Production ready.



Productivity That D

Introduced in 2005, DGD Intelligent Spindles were the first fixtured nutrunners that offered onboard servo and modular construction. Today, these third generation nutrunners are based on over 50 years of proven success of our conventional spindles.

DGD Intelligent Spindles combine high speed, exceptional up time availability, and unprecedented accuracy and durability in a compact design that requires substantially less cabling than traditional nutrunners. The result is productivity gains at a lower cost,

with up to 30% savings on initial purchase price. DGD Intelligent Spindles also offer easy integration with Cleco electric tool products, including the new Cleco Global Controller.

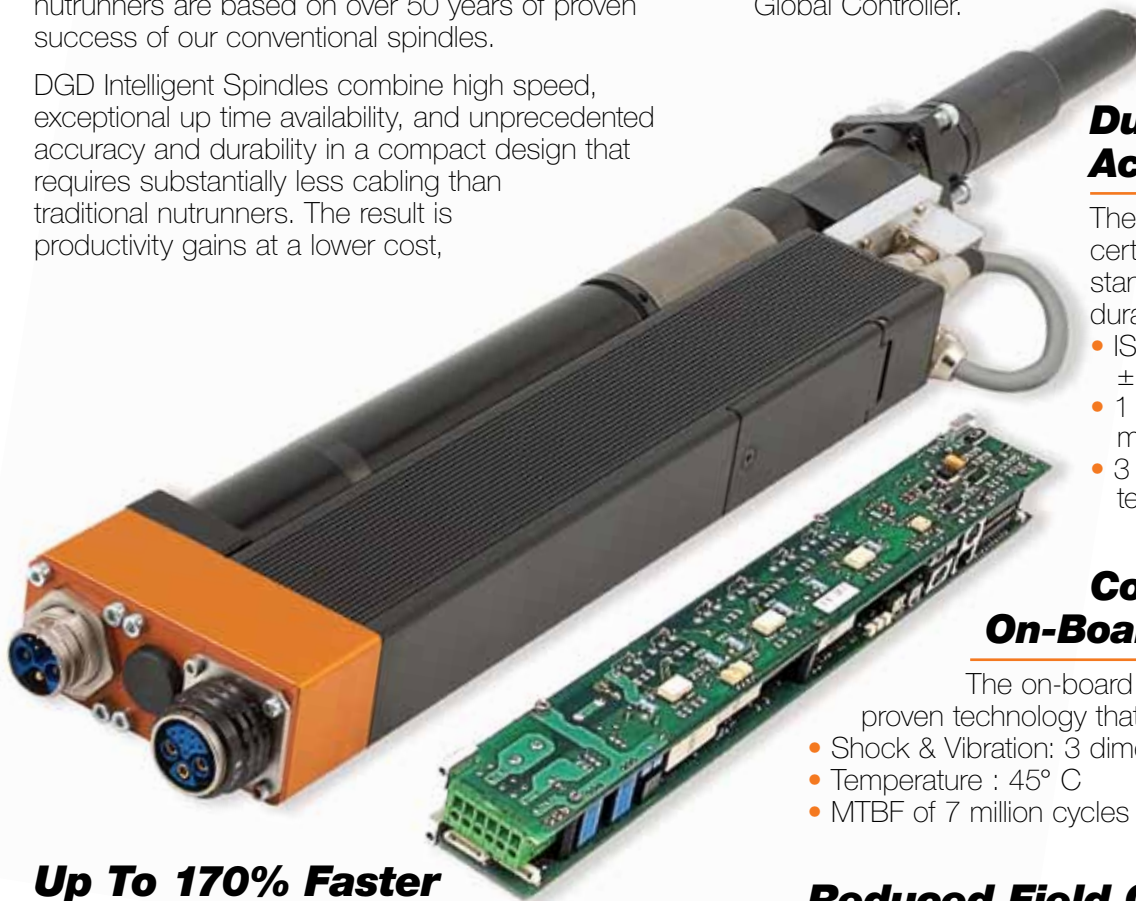

Durability & Accuracy

The BTSE nutrunners are certified to the highest standard of accuracy and durability.

- ISO certified to $\pm 2\%$ accuracy
- 1 million duty cycles maintenance free
- 3 million cycle guarantee @ 80% of capability

Compact On-Board Intelligence

The on-board servo module is proven technology that has been tested to:

- Shock & Vibration: 3 dimension at 13G
- Temperature : 45° C
- MTBF of 7 million cycles

Up To 170% Faster

With sealed, long-life, maintenance-free 380 VDC motors, DGD Intelligent Spindles are faster than a conventional spindle at most every torque level.

DGD Speed Comparison

Torque (Nm)	DGD Conventional Spindle	DGD Intelligent Spindle	DGD RPM Advantage
10	1222	1921	57%
50	329	890	170%
100	329	890	170%
150	219	502	137%
200	220	502	48%

Reduced Field Cables

DGD Intelligent Spindles provide a solution for the number-one cause of shut-down ... cable failure ... by substantially reducing the number of cables needed. Where DGD conventional spindles each need a separate cable, up to 16 Intelligent Spindles can be run from a single field cable by cascading cables between spindles.



Drives Cost Savings

Acquisition & Installation Costs Plus Floor Space Are All Reduced

DGD Conventional Spindle System Solution	DGD 10 Spindle Requirements		DGD Intelligent Spindle System Solution
	Conventional	Intelligent	
	10	Controllers	1
	10	Field Cables	1
	10	Power Interface Points	1
	5 hrs.	Cable Festooning Time	1 hr.
	5 hrs.	Controller Installation Time	1 hr.
	5 hrs.	Startup/Debug Time	3 hrs.
	6 sq.ft.	Required Floor Space	3.5 sq.ft.
	No	Ability to add additional tools to existing controller	Yes

\$avings	Time & Material
Tools, Cables & Controller	\$
Installation	\$\$\$
Parts (cables & controllers)	\$
Total System Savings	\$\$

System Simplicity

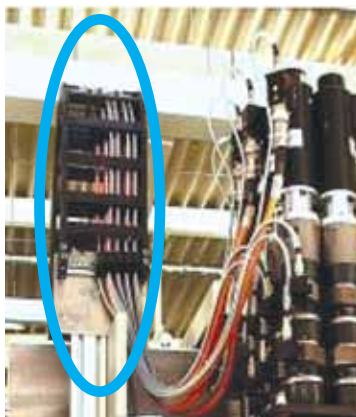

Older and more expensive DGD Conventional System

Savings with a DGD 10 Spindle Intelligent Spindle System vs. DGD Conventional System In The Following Areas

Festooning Hardware (including installation)	<input checked="" type="checkbox"/>
Installation Labor	<input checked="" type="checkbox"/>
System Field Cables	<input checked="" type="checkbox"/>
Replacement Spare Parts & Cables	<input checked="" type="checkbox"/>
Trouble Shooting Time	<input checked="" type="checkbox"/>
System Availability	<input checked="" type="checkbox"/>

Incredible Savings!



Cost effective DGD Intelligent System

Your Single Source For Custom Automated Systems

Automated Systems provides custom solutions for the automated fastening of threaded joints.

Our global customers span the entire vehicle assembly market, including passenger cars and trucks, power train assembly, off-road vehicles, and agricultural machines. We support machine tool builders in the vehicle and industrial markets with custom fastening system designs based on proven fastening product building modules.

Over many decades, Automated Systems has been providing custom solutions for training, service, and support. From single handheld nutrunners to multiple spindle machines, our custom designed systems are used around the world in an interesting variety of applications.

We have a full support staff of Sales Engineers, Mechanical Engineers, Controls Engineers, Project Managers, Field Service Engineers and In house Service Engineers waiting to serve you.

Custom Automated Solutions

The custom designed equipment Automated Systems creates can be configured in either vertical or horizontal orientations depending on the application and customer requirements

Shown are two semi-automatic DC electric systems to secure camshaft cover fasteners and water pump assembly mounting fasteners.

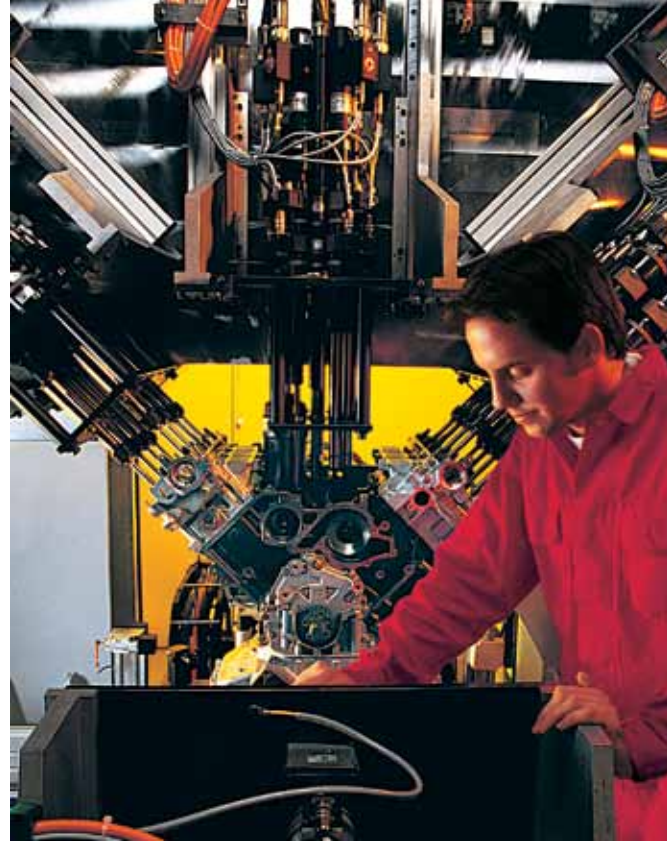
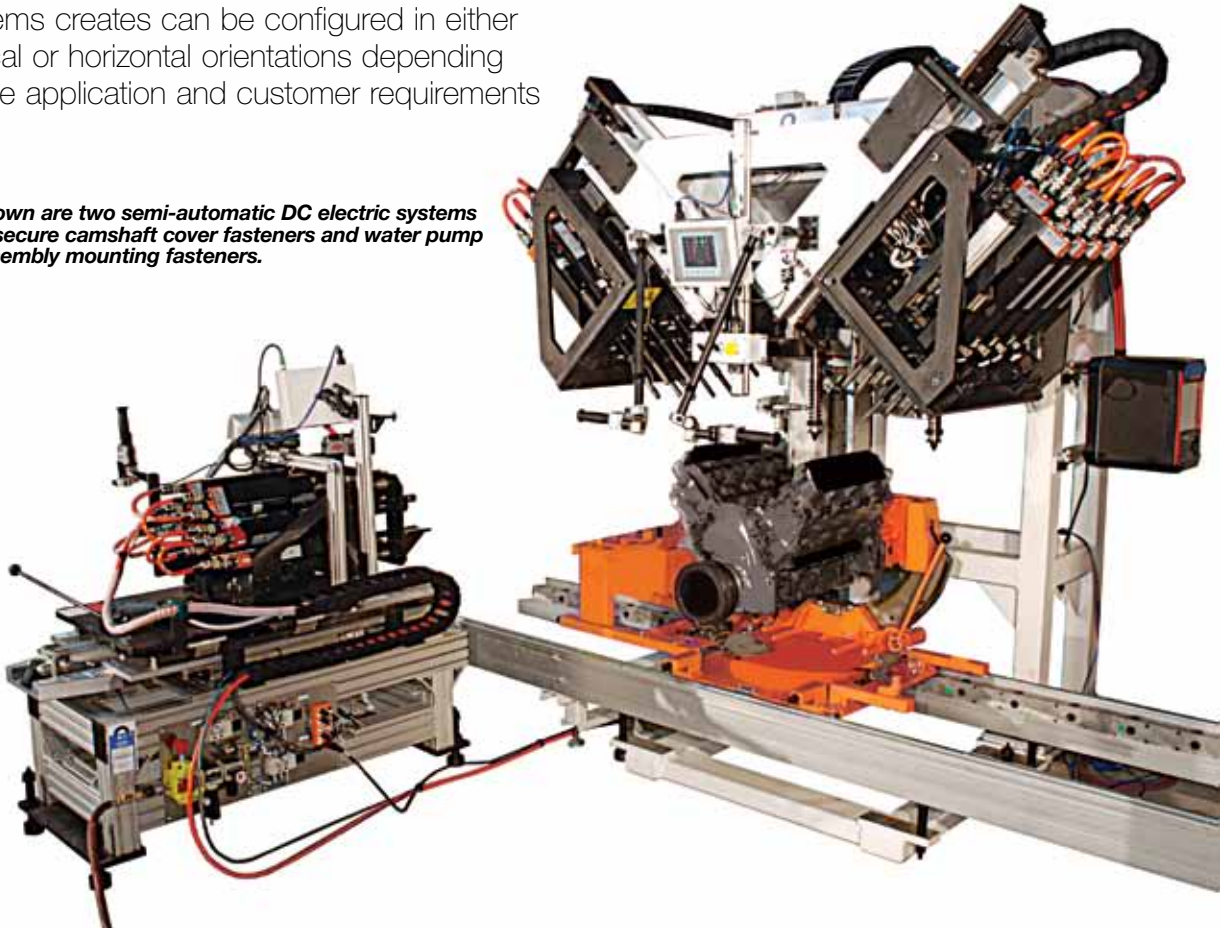

An automatic station on an engine assembly line uses two opposing electric power heads, each having 8 spindles, and a center power head of 6 spindles.

utilizing standard components. Designs may incorporate operator input or be fully automated dependent on the needs of the customer.

Automated Systems' products use high-efficiency electric motors manufactured specifically for this application. Available motor torques range from 2 Nm to 4,000 Nm. Motor spindles can be mounted and arranged to match any pattern using standard in-line, special offset, and 90° angle electric motors.

In order to apply our powerhead designs, we also design custom suspension systems along with cable management systems to provide support and movement. In addition to custom built stations fitted with fixtured nutrunner powerheads, Automated System designs, builds, installs and provides service and support from the complete fastening lines.

The left cylinder head of a V12 engine is being fastened using a 26 spindle fixtured electric multiple. The suspension system has been designed to not only support the weight of the tool, but to rotate into fastening alignment with the cylinder head on the right side of the engine.

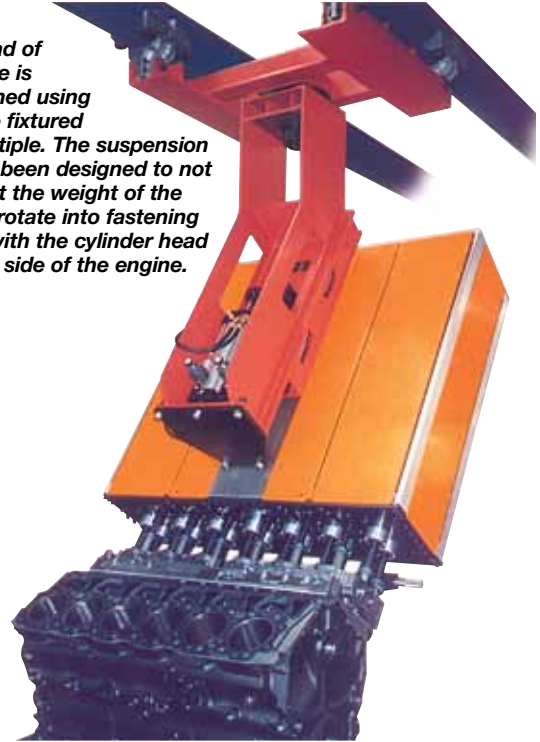

The above manually operated railroad wheel bearing multiple has the capability to tighten three (3) fasteners equally spaced on various centers between 3.50" to 5.85" diameters up to 600 NM torque.

Wheelnut Fastening

Automated Systems is the recognized leader in the design and manufacture of multiple spindle wheelnut assembly systems. We are known across the globe for excellence of innovative engineering design, support, and quality award winning service.

Decades of expertise in the design and manufacturing of multiple spindle fixtured and portable assembly systems have identified Automated Systems as an experienced, innovative supplier capable of creating custom solutions matched to unique customer assembly requirements.

Medium Duty Wheelnut Tool For Passenger Vehicles requiring Medium Torque, High Volume

- 100 Nm to 500 Nm

Automated Systems supplies custom Wheelnut multiple designs using standard major components with proven track records for reliability, lifetime performance, millions of cycles capability and ergonomic solutions which support operator safety, comfort and efficiency.



Automated Systems makes use of standard system building block components which are used to blend a custom system from a complete line of DC electric spindles, fastening controllers and an extensive listing of twenty-four different fastening strategies which not only include the usual Torque Control, Angle Control and Yield, but also includes the unusual Pulse Torque Recovery makeup torque fastening strategy awarded US Patent number 5,094,301.

Heavy Duty Wheelnut Tool For Trucks requiring High Torque, Low Volume

- 700 Nm to 1200 Nm

Automated Systems Wheelnut multiples use high-efficiency electric motors manufactured specifically for this application. Available motor torques range from 700 Nm to 1200 Nm. Motor spindles can be mounted and arranged to match any bolt circle pattern, using standard in-line motors with or without offset gearing.

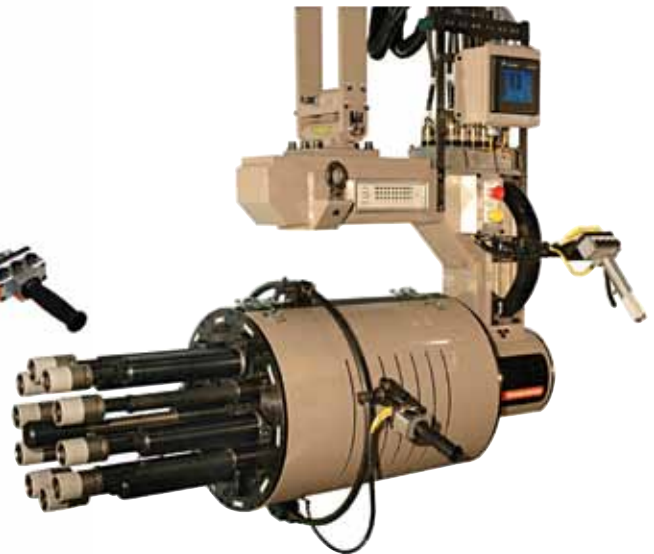

Adjustable Wheel Stud Centers

When several similar wheels need to be assembled and the economics of separate powerheads dictates a single powerhead, Automated Systems has the answer! Adjustable stud centers. The position of the studs can be controlled by an operator manual switch, or auto detection.



Budd Double Wheels

When it comes to fastening inner and outer wheel lug nuts including Budd style stud/nut adapters, a wheelnut powerhead requires long retractable spindles which are designed to prevent side loading. Automated Systems has the know-how, and the products to supply wheelnut multiples for double wheel truck applications. Our wheel equipment is more rugged than the trucks it assembles.

Suspension System

A properly designed suspension system can not only support the tool and return it to a home position, it can also provide a zero gravity lift and hold. The total weight of the tool is controlled by the operator with very little pressure required to move the tool up or down.



Local Operator Display (Operator Interface)

Each powerhead displays a red, green, and yellow LED on a per spindle basis. The LED display indicates the status of the last tightening as NOK, OK and Low Torque or Angle. An optional local operator interface display can be used to display output, and accept touch screen switch inputs.



Some of the uses of a local operator display include:

- Application selection
- Tool home position jog
- Overall fastening status in green or red
- Part graphics
- Fastening values for torque and angle
- Functional push-button inputs & display outputs



Push-off and Return

On moving transfer lines, the overhead suspension system can be mounted to an overhead track, supporting the multiple. At the conclusion of the fastening rundown by all spindles, the suspension pushes the tool away from the wheel and returns the tool to the home position ready for the next wheel. The vehicle on the assembly transfer line continues to move while the lug nuts are being tightened.

Application Detection of Aluminum and Steel Wheels

Wheel lug nut tools are distinguished from standard horizontally aligned systems by their cylindrical shape. Rotation of the tool is required for proper alignment with the wheel lugs, and the ability to provide a clear line of sight for the operator. In addition, a 6 spindle tool can be rotated 30 degrees, rundown a second time and tighten the alternate 6 lug nuts on a 12 lug nut wheel. This alternative design is tightening dual truck wheels, and can automatically determine if the wheel is aluminum or steel and change the fastening parameters automatically.



Shown are two manually operated vertical multiples and one semi-automatic DC electric systems.





Reduced Field Cables

DGD Intelligent Spindles provide a solution for the number-one cause of shut-down ... cable failure ... by substantially reducing the number of cables needed. Where DGD conventional spindles each need a separate cable, up to 16 Intelligent Spindles can be run from a single field cable by cascading cables between spindles. We offer both HighFlex for fixed or flexible routing for heavy duty requirements and SuperHighFlex for robotic and all high mobility applications. See page 76 for more details.

Benefits of Intelligent Spindle Field Cables

- Lower cost of ownership
- Higher durability
- Lower start-up cost
- Reduced cable management systems

Shown above is a ten Intelligent spindle application with nine jumper cables and a single field cable that terminates at the power distribution box.

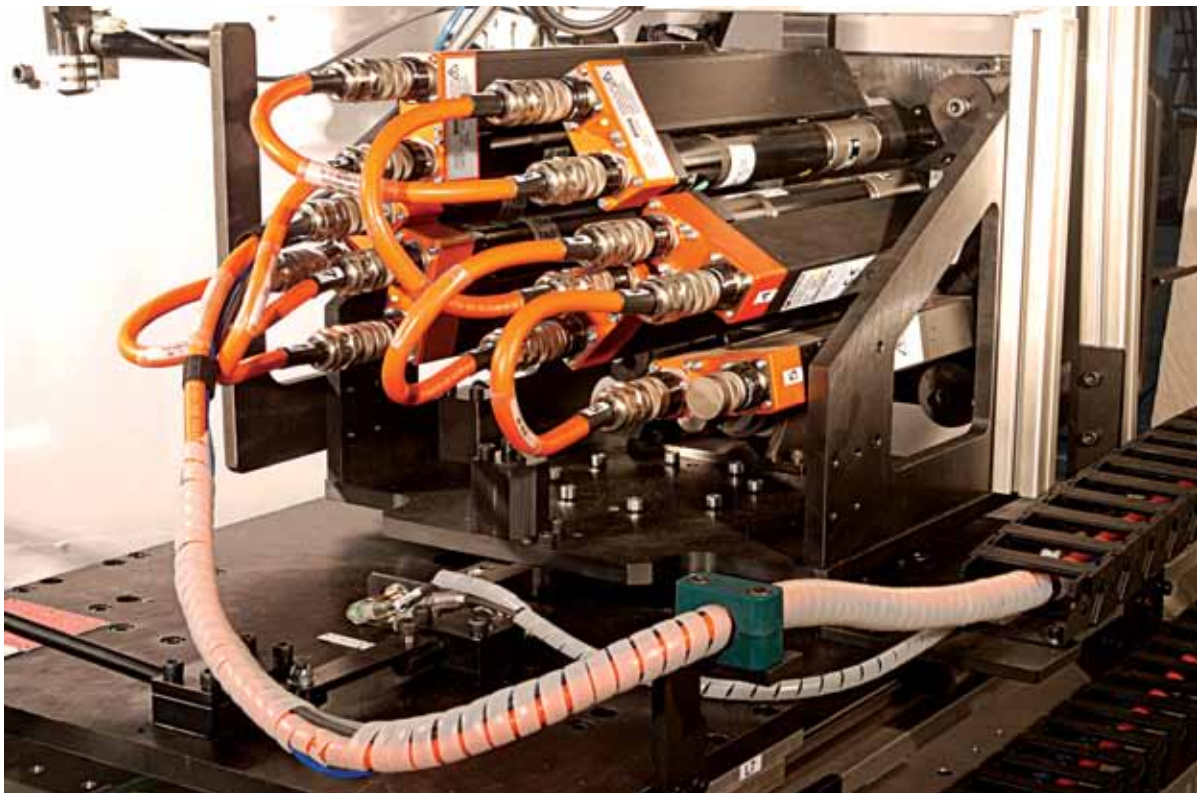

Shown above is a seven Intelligent spindle application with six jumper cables and a single field cable that terminates at the power distribution box.

How To Build A DC Fastening System

mPro400GC-M, mPro400GC-P & mPro400GC-S

Building a DC System for **Safety Critical** applications is as simple as 1, 2, 3!

1. Choose a common system to the right.
2. Select the correct components below.
3. Order your System!

(Refer to Pages 46-47 to build a mPro400GC-E/GC-I system.)

Controller (Page 114)



Corded Tool (Page 32-44)



Cable (Page 122)

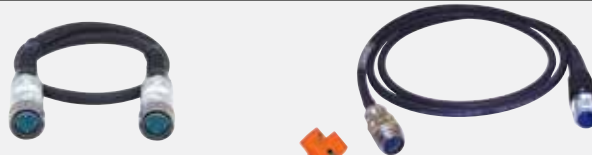

LiveWire Tool (Pages 28-31)



Access Point (Page 123)



IRDA Device (Infrared Cable) (Page 123)



System Bus Cable (Page 124)



System Bus Terminator Plug (Page 124)



System Bus Accessories (Page 124)



Isolation Transformer (Page 121)



Add or delete components as required.

Model/Part Number	One Corded Tool (18/48E-E)	One Corded Tool (18/48E-E) with a Control Box	One Corded Tool (18/48E-E) with 8-Pos Socket Tray	Two Corded Tools (18/48E-E)	Two Corded Tools (18/48E-E) with 8-Pos Socket Tray	Three Corded Tools (18/48E-E)	Three Corded Tools Only w/3 Stack Lights	Three LiveWire™ Tools Only w/3 Stack Lights	Three LiveWire™ Tools Only w/4-Position Socket Tray	Three LiveWire™ Tools Only w/8-Position Socket Tray
mPro400GC-M (Master)							1	1		
mPro400GC-P (Primary)	1	1	1	1	1	1				
mPro400GC-S (Secondary)					1		2			
18/48E_EXXX	1		1	2	1	3				
67E_XXX		1								
Tool Cable - 301866-XM (Air-Lb)	1		1	2	1	3				
Tool Cable - 542778-XM (Matrix)		1								
Extension Cable - 301877-XM (If Required) (Air-Lb)										
Extension Cable - 542779-XM (If Required) (Matrix)										
17/47B__BXX			1				1	3		
544249PT			1				1	1		
935170 IRDA Only 935144 Pistol Holder w/IRDA 935290 Right Angle Holder w/IRDA 935999 70Nm, 90Nm, Crowfoot/Tubenut Holder w/IRDA			1				1	1		
544196-005 (0.5M) 544196-020 (2M) 544196-050 (5M) 544196-200 (20M) 544196-500 (50M)		1		2	1	2		3		
544197PT		1		1	1	1		1		
S133420 Stack Light										3
S133410 4-Position Socket Tray					1					
S133411 8-Position Socket Tray				1						
S133406 Control Box		1								
544185PT		1								

Electric Nutrunners – Cordless Transducer Control

Right Angle Tools

Cleco®

Right Angle Series

Torque Range
5.5 - 90 Nm
4.1 - 77.4 Ft. Lbs.

Bolt Size
M5 - M12
#10 - 9/16"

- Brushless precision
- Resolver control
- Transducer accuracy
- On-board controller with power management
- Integrated servo with I/O signal handling

47BAYSB28AM3

(Apex u-Guard socket shown above not included)



Cordless Tools Nomenclature

47	B	A	X	X	B	XX	XXX	X
Motor 47	Power B-Battery				Battery B - 26-48V		Output Drive AM3 - 3/8" Sq.Dr. AH4 - 1/2" Sq.Dr.	Retainer - Pin Retainer B Ball Retainer
Tool Style A - Angle		Peripherals S - Barcode Scanner - - None			Max Torque (Nm) Under 60Nm, rounded up to the nearest 1Nm. Over 60Nm, rounded to the nearest 5Nm.			
Data Transmission X - 2.4 GHz WLAN: WEP, WPA, WPA2, 802.1x Y - Dual Band - 2.4/5 GHz WLAN: WEP, WPA, WPA2, 802.1x Z - Xbee (4 tools/base station) R - RF868MHz (4 tools/base station) EU only								

Right Angle Model Number	Torque Range		Free Speed (RPM)			Weight Less Battery		Output Drive Size	Length With 26V Battery	
	Ft.Lbs.	Nm	26V*	44V*	Vmax	lbs.	kg		in.	mm
47BAYSB15AM3	4.1-11.1	5.5-15	538	983	983	4.77	2.17	3/8" SQ	21.79	553.5
47BAYSB21AM3	5.9-15.5	8-21	411	751	751	4.77	2.17	3/8" SQ	21.79	553.5
47BAYSB28AM3	7.4-20.7	10-28	291	532	532	4.77	2.17	3/8" SQ	22.32	567.5
47BAYSB35AM3	9.6-25.8	12-35	244	447	447	5.35	2.43	3/8" SQ	23.06	600.0
47BAYSB50AM3	13.3-36.9	18-50	168	293	293	5.39	2.45	3/8" SQ	23.94	608.0
47BAYSB70AH4	17.7-66.3	24-70	123	216	216	8.54	3.88	1/2" SQ	26.7	678.0
47BAYSB90AH4**	29.5-77.4	40-90	82	144	144	8.73	3.96	1/2" SQ	26.7	678.0

*Speed with fully charged battery.

**Non-released model available for specific applications only.

Contact Regional Application Center for implementation assistance.

General: All tools must be used with a Cleco approved line controller.

Standard Equipment: Integrated infrared communications.

Extra Equipment: See pages 123-125 for optional accessories.



17BPYSB13Q

(Apex u-Guard socket shown above not included)

Cleco®

Pistol Grip Series

Torque Range	Bolt Size
3.0 - 13 Nm	M5 - M6
2.2 - 9.6 Ft. Lbs.	#10 - 1/4"

- Brushless precision
- Resolver control
- Transducer accuracy
- On-board controller with power management
- Integrated servo with I/O signal handling



Cordless Tools Nomenclature

17	B	P	X	X	B	XX	Q
Motor 17	Power B-Battery				Battery B - 26-48V		Output Drive Q - Quick change
Tool Style		Peripherals			Max Torque (Nm)		
P - Pistol		S - Barcode Scanner - - None			Under 60Nm, rounded up to the nearest 1Nm.		
Data Transmission							
X - 2.4 GHz WLAN: WEP, WPA, WPA2, 802.1x							
Y - Dual Band - 2.4/5 GHz WLAN: WEP, WPA, WPA2, 802.1x							
Z - Xbee (4 tools/base station)							
R - RF868MHz (4 tools/base station) EU only							

Pistol Model Number	Torque Range		Free Speed (RPM)			Weight Less Battery		Output Drive Size	Length With 26V Battery	
	Ft.Lbs.	Nm	26V*	44V*	Vmax	lbs.	kg		in.	mm
17BPYSB05Q	2.2-3.7	3-5	1639	2428	2428	3.34	1.52	1/4" Hex	8.44	214.5
17BPYSB07Q	2.2-5.2	3-7	1161	1721	1721	3.34	1.52	1/4" Hex	8.44	214.5
17BPYSB09Q	2.2-6.6	3-9	887	1314	1314	3.34	1.52	1/4" Hex	8.44	214.5
17BPYSB13Q	2.2-9.6	3-13	629	931	931	3.34	1.52	1/4" Hex	8.44	214.5

*Speed with fully charged battery.

General: All tools must be used with a approved Cleco line controller.

Standard Equipment: Integrated infrared communications.

Extra Equipment: See pages 123-125 for optional accessories.

Electric Nutrunners – Cordless Transducer Control

Tube Nut Tools

Cleco®

Tube Nut Series

Torque Range
10 - 40 Nm
7.4 - 29.5 Ft. Lbs.

Bolt Size
M6 - M8
1/4" - 7/16"

- Brushless precision
- Resolver control
- Transducer accuracy
- On-board controller with power management
- Integrated servo with I/O signal handling

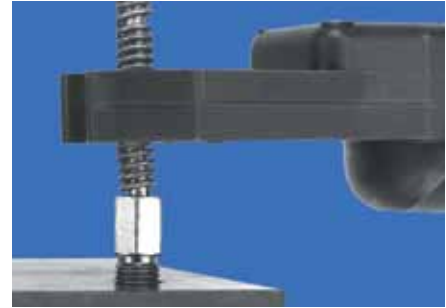

The 47BT tube nut wrench alternates the direction of rotation each time the lever is actuated. When rotating in reverse, the socket will stop at the open position.



47BTYSB20T2

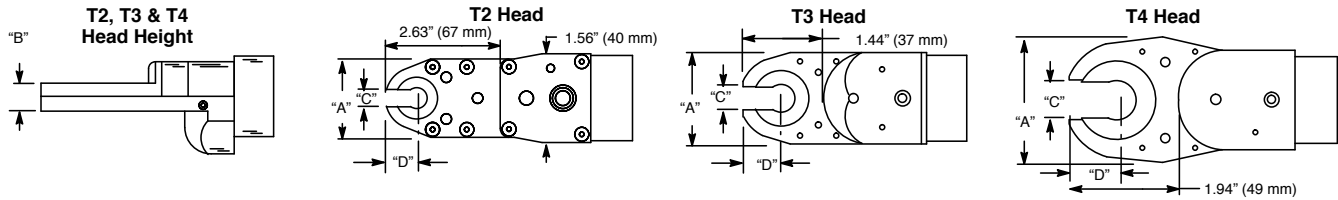

Tube Nut Tool Nomenclature

47	B	T	X	X	X	XX	XX	KSX	XX	XX	X
Series 47	Power B-Battery							Head Type KS2 - T2 KS3 - T3 KS4 - T4			Output Type 0 - Partial Thru Hex 1 - Thru Hex 2 - Double Thru Hex 3 - Partial Thru Double Hex
Tool Style T - Tube Nut					Peripherals S - Barcode Scanner - - None		Head Type T2 - 20 Nm T3 - 30 Nm T4 - 40 Nm			Extension Length 0 - Flush 2 - 1/4" 4 - 1/2" 6 - 3/4"	
Data Transmission X - 2.4 GHz WLAN: WEP, WPA, WPA2, 802.1x Y - Dual Band - 2.4/5 GHz WLAN: WEP, WPA, WPA2, 802.1x Z - Xbee (4 tools/base station) R - RF868MHz (4 tools/base station) EU only				Battery B-26V-48V			Max Torque (Nm) Under 60Nm, rounded up to the nearest 1Nm. Over 60Nm, rounded to the nearest 5Nm.			Maximum Hex Socket Size MG, EE MM MU 00, ## (Specials)	

Socket Sizes

EA - 1/4"	M5 - 5mm	MH - 14mm	MP - 22mm
EC - 3/8	M6 - 6mm	MI - 15mm	MQ - 23mm
EE - 1/2	MA - 7mm	MJ - 16mm (5/8")	MR - 24mm (15/16")
EF - 9/16	MB - 8mm (5/16)	MK - 17mm	MS - 25mm
EH - 11/16	MD - 10mm	ML - 18mm	MT - 26mm
EJ - 13/16	ME - 11mm (7/16)	MM - 19mm (3/4")	MU - 27mm (1 1/16")
EK - 7/8	MF - 12mm	MN - 20mm	
EM - 1	MG - 13mm	MO - 21mm	

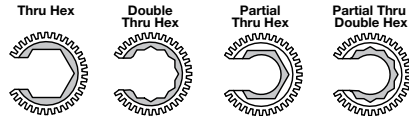

Tube Nut	Torque Range		Free Speed (RPM)			Weight Less Battery		Max. Drive Size	Length w/ 26V Battery	Head								
	Model Number	Ft.Lbs.	Nm	26V*	44V*	Vmax	lbs.			kg	A Width		B Blade Ht.		C Opening		D End/Cntr.	
47BTYSB20T2	7.4-14.8	10-20	260	455	455	5.6	2.54	1/2"	23.6	598	1.42	36	0.55	14	0.28	7	0.53	13
47BTYSB30T3	11.1-22.1	15-30	188	329	329	5.6	2.53	3/4"	23.3	588	1.65	42	0.59	15	0.475	12	0.73	19
47BTYSB40T4	14.8-29.5	20-40	141	247	247	6.4	2.90	1 1/16"	29.9	612	2.36	60	0.59	15	0.675	17	0.93	24

*Speed with fully charged battery.

General: All tools must be used with a Cleco approved line controller.

Standard Equipment: Integrated infrared communications.

Extra Equipment: See pages 123-125 for optional accessories.

To order individual sockets, use a "KS" prefix. (i.e. KS2EA01 for a T2, 1/4", flush, thru hex socket.)

Cleco®

Crowfoot Series

Torque Range
10.5 - 30 Nm
7.7 - 22.1 Ft. Lbs.

Bolt Size
M6 - M8
1/4" - 7/16"

- Brushless precision
- Resolver control
- Transducer accuracy
- On-board controller with power management
- Integrated servo with I/O signal handling



47BCYSB30C1

C1 – 15° Head (Part No. 301959)

Maximum Recommended Torque: 22 ft.lbs. (30 Nm)

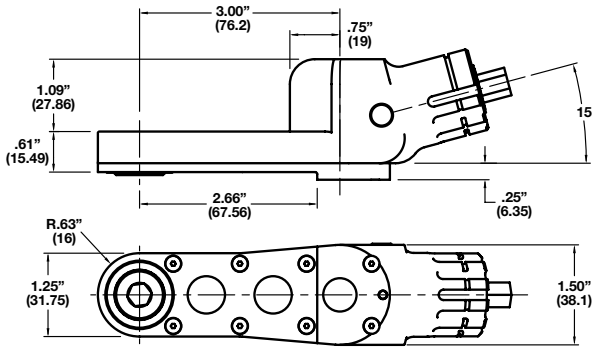

C3 – 30° Head (Part No. 301960)

Maximum Recommended Torque: 22 ft.lbs. (30 Nm)

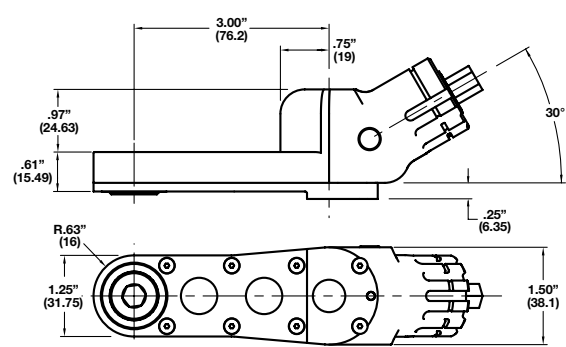

Crowfoot Tool Nomenclature

47 | **B** | **C** | **X** | **X** | **B** | **XX** | **XX** | **CS** | **XX** | **X** | **X**

Series
47

Battery
B – 26V-48V

Tool Style
C – Crowfoot

Peripherals
– None
S – Barcode scanner

Data Transmission
X – 2.4 GHz WLAN: WEP, WPA, WPA2, 802.1x
Y – Dual Band – 2.4/5 GHz WLAN: WEP, WPA, WPA2, 802.1x
Z – Xbee (4 tools/base station)
R – RF868MHz (4 tools/base station) EU only

Head Type
C1 – 15°
C3 – 30°

Max Torque (Nm)
Under 60Nm, rounded up to the nearest 1Nm. Over 60Nm, rounded to the nearest 5Nm.

Socket Nomenclature

Socket Type
CS – Crowfoot

Output Type
1 – Thru Hex

Extension Length
0 – Flush 4 – 1/2" 6 – 3/4"

Socket Size

EA – 1/4"	MA – 7mm	MF – 12mm
EC – 3/8	MB – 8mm (5/16)	MG – 13mm
EE – 1/2	MC – 9mm	MH – 14mm
EF – 9/16	MD – 10mm	MI – 15mm*
	ME – 11mm (7/16)	

*Fragile. Light duty apps.

Crowfoot Model Number	Torque Range		Free Speed (RPM)			Weight Less Battery		Max. Drive Size	Length w/26V Battery	
	ft. lbs.	Nm	26V*	44V*	Vmax	lbs.	kg		in.	mm
47BCYSB30C1	7.7-22.1	10.5-30	186	326	326	6.12	2.78	1/2"	26.26	667
47BCYSB30C3	7.7-22.1	10.5-30	186	326	326	6.12	2.78	3/4"	25.98	660

*Speed with fully charged battery.

General: All tools must be used with a Cleco approved line controller.

Standard Equipment: Integrated infrared communications.

Extra Equipment: See pages 123-125 for optional accessories.

To order individual sockets, use a "CS" prefix before the required socket. (i.e. CSEE01 for a 1/2", flush, thru hex socket.)

Electric Nutrunners – Coded Transducer Control

Right Angle Tools

Cleco®

Right Angle Series

Torque Range
2 - 230 Nm
1.5 - 169.6 Ft. Lbs.

Bolt Size
M5 - M16
#10 - 5/8"

- Brushless precision
- Resolver control
- Transducer control
- Memory intelligence



XX	E	A	E	XXX	XXX	X
Motor 18, 48	Power E-Electric	Connector Air-LB				Retainer - Pin retainer B Ball retainer
Tool Style A – Right Angle				Output Drive		
Max Output Torque (Nm) Under 60 Nm, rounded up to the nearest 1 Nm. Over 60 Nm, rounded to the nearest 5 Nm.				AL2 – 1/4" Sq.Dr. AM4 – 1/2" Sq.Dr. AL3 – 3/8" Sq.Dr. AH4 – 1/2" Sq.Dr. AM3 – 3/8" Sq.Dr. MH4 – 1/2" Sq.Dr. AX6 – 3/4" Sq.Dr.		

Right Angle	Torque Range		Max. Speed	Weight*		Output Drive Size	Length		Anglehead					
	ft. lbs.	Nm		lbs.	kg		in.	mm	Side to Center		Height			
Model Number			RPM						in.	mm	in.	mm	in.	mm
18EAE08AL2	1.5-5.9	2-8	3000	2.9	1.3	1/4"	13.6	345	0.51	13	1.4	36		
18EAE15AM3	3.0-11.1	4-15	1300	3.3	1.5	3/8"	14.8	376	0.59	15	1.6	41		
18EAE22AM3	3.7-16.2	5-22	920	3.3	1.5	3/8"	14.8	376	0.59	15	1.6	41		
18EAE28AM3	4.4-20.7	6-28	700	3.3	1.5	3/8"	14.8	376	0.59	15	1.6	41		
48EAE15AL3	2.2-11.1	3-15	2855	3.8	1.7	3/8"	15.7	398	0.59	15	1.6	41		
48EAE28AL3	4.4-20.7	6-28	1300	4.1	1.9	3/8"	16.2	410	0.59	15	1.6	41		
48EAE41AM3	6.6-30.2	9-41	1090	4.3	2.0	3/8"	17.3	440	0.75	19	1.9	48		
48EAE58AM3	8.9-42.8	12-58	770	4.3	2.0	3/8"	17.3	440	0.75	19	1.9	48		
48EAE58AM4	8.9-42.8	12-58	770	4.3	2.0	1/2"	17.3	440	0.75	19	1.9	48		
48EAE90AH4	13.3-64.2	18-87	515	6.6	3.0	1/2"	18.5	470	0.81	21	2.3	58		
48EAE105AH4	15.5-76.7	21-104	340	6.6	3.0	1/2"	18.5	470	0.81	21	2.3	58		
48EAE135MH4	19.9-98.1	27-133	265	7.3	3.3	1/2"	19.1	485	0.94	24	2.4	61		
48EAE175AX6	26.6-129.8	36-176	190	10.2	4.6	3/4"	21.6	549	1.06	27	2.7	69		
48EAE230AX6	33.9-169.6	46-230	145	10.2	4.6	3/4"	21.6	549	1.06	27	2.7	69		

*Weights are without tool cable and reaction bar.

General: All tools must be used with an approved ATG cable and controller.

Standard Equipment: Air-LB Connector. Ball retainer optional.

Tools with Matrix connector available upon request

Extra Equipment: Std. tool cable 301866-XX, RA swivel cable 301903-XX,

Inline swivel cable 301904-XX, Extension cable 301877-XX.

Additional Accessories: See pages 121-129 for additional accessories.



Cleco®

Right Angle Series

Torque Range
46 - 2000 Nm
34 - 1475 Ft. Lbs.

Bolt Size
M18 - M36
3/4" - 1 1/2"

- Brushless precision
- Resolver control
- Transducer control
- Memory intelligence

All 67 Series Tools require an isolation transformer (544185PT) for use with Cleco Global Controller.

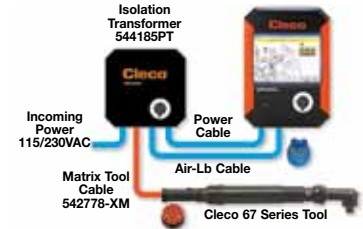

XX	E	A	XXXX	XXX	X
Motor 67	Power E-Electric				Retainer - Pin retainer B Ball retainer
Tool Style A - Right Angle			Output Drive AL6 - 3/4" Sq.Dr. AM6 - 3/4" Sq.Dr. ML6 - 3/4" Sq.Dr. AH8 - 1" Sq.Dr.		
Max Output Torque (Nm) Under 60 Nm, rounded up to the nearest 1 Nm. Over 60 Nm, rounded to the nearest 5 Nm.					

Right Angle Model Number	Torque Range		Max. Speed RPM	Weight*		Output Drive Size	Length		Anglehead			
	ft. lbs.	Nm		lbs.	kg		in.	mm	Side to Center		Height	
									in.	mm	in.	mm
67EA235AL6	33.9-169.6	46-230	135	12.9	5.9	3/4"	25.8	655	1.03	26	2.3	58
67EA255AL6	40.6-188.1	55-255	115	12.9	5.9	3/4"	25.8	655	1.03	26	2.3	58
67EA310ML6	44-229	60-310	100	20.2	9.2	3/4"	29.1	739	1.06	27	2.55	65
67EA340AM6	51.6-247.1	70-335	90	21.0	9.5	3/4"	31.6	803	1.38	35	3.1	79
67EA460AM6	70.1-339.3	95-460	66	21.0	9.5	3/4"	31.6	803	1.38	35	3.1	79
67EA570AM6†	84.8-420.4	115-570	53	21.0	9.5	3/4"	31.6	803	1.38	35	3.1	79
67EA860AH8	129.1-634.3	175-860	33	22.7	10.3	1"	25.3	643	1.50	38	9.32	237
67EA1035AH8	154.9-763.3	210-1035	25	23.0	10.5	1"	26.3	668	1.50	38	9.32	237
67EA1340AH8	199.1-988.3	270-1340	20	23.0	10.5	1"	26.3	668	1.50	38	9.32	237
67EA1700AH8	250.8-1253.8	340-1700	16	23.0	10.5	1"	26.3	668	1.50	38	9.32	237
67EA2010AH8	295.0-1475.0	400-2000	13	23.0	10.5	1"	26.3	668	1.50	38	9.32	237

*Weights are without tool cable and reaction bar.

†Note: All 67 series tools require an isolation transformer (544185PT) for use with Cleco Global Controller.

‡Note: Contact regional application center for implementation assistance.

General: All tools must be used with an approved ATG cable and controller.

Standard Equipment: Matrix Connector.

Extra Equipment: Std. tool cable 542778-XX, RA swivel cable 544055-XX, Inline swivel cable 544056-XX, Extension cable 542779-XX.

Additional Accessories: See pages 121-129 for additional accessories.

Electric Nutrunners – Coded Transducer Control

Inline Non-Floating Spindle Tools

Cleco®

Inline Non-Floating Series

Torque Range
2 - 150 Nm
1.5 - 110 Ft. Lbs.

Bolt Size
M5 - M14
#10 - 5/8"

- Brushless precision
- Resolver control
- Transducer control
- Memory intelligence

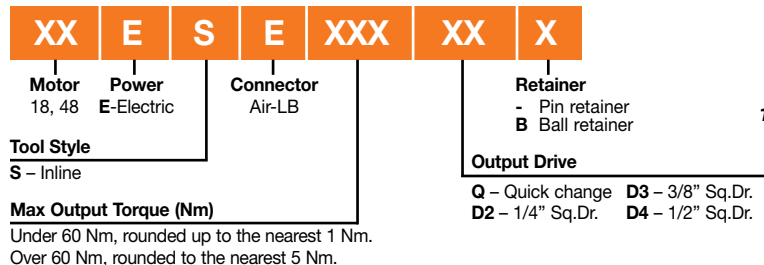

Inline Non-Floating Model Number	Torque Range		Max. Speed RPM	Weight*		Output Drive Size	Length		Side to Center	
	ft. lbs.	Nm		lbs.	kg		in.	mm	in.	mm
18ESE06Q	1.5-4.4	2-6	4000	2.5	1.1	1/4" Hex	12.3	312	0.91	23
18ESE06D2	1.5-4.4	2-6	4000	2.5	1.1	1/4"	11.8	300	0.91	23
18ESE12Q	2.2-8.9	3-12	1820	2.7	1.2	1/4" Hex	13.0	330	0.91	23
18ESE12D3	2.2-8.9	3-12	1820	2.7	1.2	3/8"	12.4	315	0.91	23
18ESE17Q	3.0-12.5	4-17	1290	2.7	1.2	1/4" Hex	13.0	330	0.91	23
18ESE17D3	3.0-12.5	4-17	1290	2.7	1.2	3/8"	12.4	315	0.91	23
18ESE22D3	3.7-16.2	5-22	985	2.7	1.2	3/8"	12.4	315	0.91	23
18ESE31D3	5.2-22.9	7-31	695	2.7	1.2	3/8"	12.4	315	0.91	23
48ESE12Q	2.2-8.9	3-12	4000	3.0	1.4	1/4" Hex	13.5	343	0.91	23
48ESE12D2	2.2-8.9	3-12	4000	3.0	1.4	1/4"	13.0	330	0.91	23
48ESE25D3	4.4-18.4	6-25	1820	3.2	1.5	3/8"	13.6	345	0.91	23
48ESE36D3	5.9-26.6	8-36	1290	3.2	1.5	3/8"	13.6	345	0.91	23
48ESE48D3	7.4-35.4	10-48	985	3.3	1.5	3/8"	13.8	351	0.91	23
48ESE65D4	9.6-47.9	13-65	750	5.3	2.4	1/2"	16.6	420	1.13	29
48ESE90D4	14.0-66.4	19-90	510	5.6	2.5	1/2"	17.1	435	1.13	29
48ESE125D4	19.2-92.2	26-125	360	5.6	2.5	1/2"	17.1	435	1.13	29
48ESE150D4	22.9-110.6	31-150	240	5.6	2.5	1/2"	17.1	435	1.13	29

*Weights are without tool cable.

General: All tools must be used with an approved ATG cable and controller.

Standard Equipment: Air-LB Connector; Dead Handle is included with 18ES12Q and 18ES12D3. Ball retainer optional.

Tools with Matrix connector available upon request.

Reaction bar is included with inline tools with output torques of 17-150 NM.

Extra Equipment: Std. tool cable 301866-XX, RA swivel cable 301903-XX, Inline swivel cable 301904-XX, Extension cable 301877-XX.

Mounting Plates: 543231 - (all with exception of listed below)

543235 - 18ESE06Q/D2, 48ESE12Q/D2

49087108 - 48ESE65D4, 48ESE90D4, 48ESE125D4, & 48ESE150D4.

See page 127 for mounting plate dimensions.

Additional Accessories: See pages 121-129 for additional accessories.



Cleco®

Inline Non-Floating Series

Torque Range
 13 - 4050 Nm
 10 - 2985 Ft. Lbs.

Bolt Size
 M10 - M42
 7/16" - 1 3/4"

- Brushless precision
- Resolver control
- Transducer control
- Memory intelligence

All 67 Series Tools require an isolation transformer (544185PT) for use with Cleco Global Controller.



67ES135D4

XX	E	S	XXXX	XXX	X
Motor 67	Power E-Electric				Retainer - Pin retainer B Ball retainer
Tool Style			Output Drive		
S - Inline			D4 - 1/2" Sq.Dr. D8 - 1" Sq.Dr. D6 - 3/4" Sq.Dr. D12 - 1 1/2" Sq.Dr.		
Max Output Torque (Nm)					
Under 60 Nm, rounded up to the nearest 1 Nm. Over 60 Nm, rounded to the nearest 5 Nm.					

Inline Non-Floating Model Number	Torque Range		Max. Speed RPM	Weight*		Output Drive Size	Length		Side to Center	
	ft. lbs.	Nm		lbs.	kg		in.	mm	in.	mm
67ES65D4	10-47	13-64	535	10.3	4.7	1/2"	21.0	533	1.31	33
67ES105D4	15-77	21-104	330	10.3	4.7	1/2"	21.0	533	1.31	33
67ES135D4	20-100	27-135	245	10.3	4.7	1/2"	21.0	533	1.31	33
67ES190D6	28-140	38-190	165	11.6	5.3	3/4"	20.5	521	1.31	33
67ES285D6	42-210	57-285	115	11.6	5.3	3/4"	20.5	521	1.31	33
67ES385D6	57-285	77-386	83	11.6	5.3	3/4"	20.5	521	1.31	33
67ES475D6	70-350	95-475	67	12.0	5.4	3/4"	20.9	531	1.31	33
67ES610D6	90-450	122-610	50	12.0	5.4	3/4"	20.9	531	1.31	33
67ES850D8	125-625	170-848	33	17.0	7.7	1"	23.8	605	1.50	38
67ES1050D8	155-775	210-1050	27	17.0	7.7	1"	23.8	605	1.50	38
67ES1670D8	246-1230	334-1668	17	17.0	7.7	1"	23.8	605	1.50	38
67ES2060D8	304-1520	412-2060	14	17.0	7.7	1"	23.8	605	1.50	38
67ES4050D12	597-2985	810-4050	6	45.2	20.5	1 1/2"	24.5	622	2.35	60

*Weights are without tool cable or reaction bar if so equipped.

Note: All 67 series tools require an isolation transformer (544185PT) for use with Cleco Global Controller.

General: All tools must be used with an approved ATG cable and controller.

Standard Equipment: Matrix Connector; Reaction bar; Slave drive reaction bar on 67ES4050D12.

Extra Equipment: Std. tool cable 542778-XX, RA swivel cable 544055-XX, Inline swivel cable 544056-XX, Extension cable 542779-XX.

Additional Accessories: See pages 121-129 for additional accessories.

Electric Nutrunners – Coded Transducer Control

Pistol Grip Tools

Cleco®

Pistol Grip Series

Torque Range
2 - 1000 Nm
1.5 - 740 Ft. Lbs.

Bolt Size
M5 - M22
#10 - 1"

- Brushless precision
- Resolver control
- Transducer control
- Memory intelligence

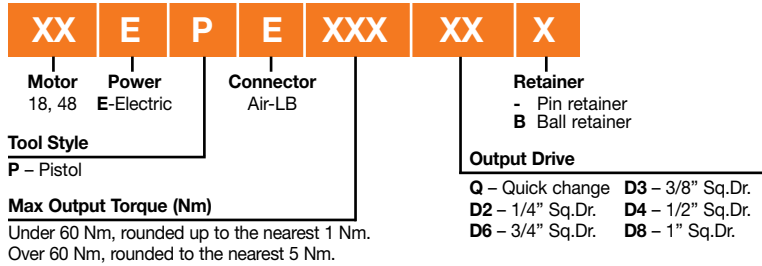

Pistol Grip Model Number	Torque Range		Max. Speed RPM	Weight*		Output Drive Size	Length		Side to Center	
	ft. lbs.	Nm		lbs.	kg		in.	mm	in.	mm
18EPE06Q	1.5-4.4	2-6	4000	2.2	1.0	1/4" Hex	7.0	178	0.84	21
18EPE06D2	1.5-4.4	2-6	4000	2.2	1.0	1/4"	6.5	165	0.84	21
18EPE12Q	2.2-8.9	3-12	1820	2.4	1.1	1/4" Hex	7.7	196	0.84	21
18EPE12D3	2.2-8.9	3-12	1820	2.4	1.1	3/8"	7.2	183	0.84	21
18EPE17Q	3.0-12.5	4-17	1290	2.4	1.1	1/4" Hex	7.7	196	0.84	21
18EPE17D3	3.0-12.5	4-17	1290	2.4	1.1	3/8"	7.2	183	0.84	21
18EPE22D3	3.7-16.2	5-22	985	2.4	1.1	3/8"	7.2	183	0.84	21
18EPE31D3	5.2-22.9	7-31	695	2.4	1.1	3/8"	7.2	183	0.84	21
48EPE12Q	2.2-8.9	3-12	4000	2.7	1.2	1/4" Hex	8.2	208	0.84	21
48EPE12D2	2.2-8.9	3-12	4000	2.7	1.2	1/4"	7.7	196	0.84	21
48EPE25D3	3.7-18.4	5-25	1820	2.9	1.3	3/8"	8.4	213	0.84	21
48EPE36D3	5.9-26.6	8-36	1290	2.9	1.3	3/8"	8.4	213	0.84	21
48EPE48D3	7.4-35.4	10-48	985	3.0	1.4	3/8"	8.6	218	0.84	21
48EPE65D4	9.6-47.9	13-65	750	5.0	2.3	1/2"	11.4	290	1.1	28
48EPE90D4	14.0-66.4	19-90	510	5.3	2.4	1/2"	12.0	305	1.1	28
48EPE125D4	19.2-92.2	26-125	360	5.3	2.4	1/2"	12.0	305	1.1	28
48EPE150D4	22.9-110.6	31-150	240	5.3	2.4	1/2"	12.0	305	0.9	23
48EPE200D6 (swing bar)	92-144	125-195	180	9.5	4.3	3/4"	16.2	410	1.13	29
48EPE500D6 (swing bar)	225-368	300-500	53	9.8	4.5	3/4"	16.2	410	1.13	29
48EPE1000D8 (swing bar)	370-740	500-1000	33	16.2	7.3	1"	19.16	486	1.5	38

*Weights are without tool cable or suspension bail.

General: All tools must be used with an approved ATG cable and controller.

Standard Equipment: Air-LB Connector; Suspension Bail; Dead Handle is included with 18EPE12Q & 18EPE12D3. Reaction bar is included with pistol tools with output torques of 17-1000 Nm. Ball retainer optional.

Tools with Matrix connector available upon request.

Extra Equipment: Std. tool cable 301866-XX, RA swivel cable 301903-XX, Inline swivel cable 301904-XX, Extension cable 301877-XX.

Additional Accessories: See pages 121-129 for additional accessories.



18EPE06QP



18ESE06QP

Cleco®

Push-to-Start Series

Torque Range
2 - 12 Nm
1.5 - 8.9 Ft. Lbs.

Bolt Size
M5 - M6
#10 - 1/4"

- Brushless precision
- Resolver control
- Transducer control
- Memory intelligence

XX	E	P	E	XX	XX	P
Motor 18, 48	Power E-Electric	Connector Air-LB		Push-to-Start		
Tool Style				Output Drive		
P - Pistol S - Inline				Q - Quick change D3 - 3/8" Sq.Dr.		
Max Output Torque (Nm)				Under 60 Nm, rounded up to the nearest 1 Nm.		

Push-to-Start Model Number	Torque Range		Max. Speed RPM	Weight*		Output Drive Size	Length		Side to Center	
	ft. lbs.	Nm		lbs.	kg		in.	mm	in.	mm
18EPE06QP	1.5-4.4	2-6	4000	2.66	1.19	1/4" Hex	9.35	238	0.84	21
18EPE06D3P	1.5-4.4	2-6	4000	2.66	1.19	3/8"	8.8	224	0.84	21
18EPE12QP	2.2-8.9	3-12	1820	2.83	1.27	1/4" Hex	9.35	196	0.84	21
18EPE12D3P	2.2-8.9	3-12	1820	2.83	1.27	3/8"	8.8	224	0.84	21
18ESE06QP	1.5-4.4	2-6	4000	2.93	1.31	1/4" Hex	14.75	375	0.91	23
18ESE06D3P	1.5-4.4	2-6	4000	2.93	1.31	3/8"	14.20	360	0.91	23
18ESE12QP	2.2-8.9	3-12	1820	3.10	1.40	1/4" Hex	14.75	375	0.91	23
18ESE12D3P	2.2-8.9	3-12	1820	3.10	1.40	3/8"	14.20	360	0.91	23

*Weights are without tool cable or suspension bail.

General: All tools must be used with an approved ATG cable and controller.

Standard Equipment: Air-LB Connector; Suspension Bail (pistol only); Dead Handle (301857) is included with 18CPE12Q & 18CPE12D3.

Tools with Matrix connector available upon request.

Extra Equipment: Std. tool cable 301866-XX, RA swivel cable 301903-XX, Inline swivel cable 301904-XX, Extension cable 301877-XX.

Additional Accessories: See pages 121-129 for additional accessories.

Electric Nutrunners – Corded Transducer Control

Inline Floating Spindle Tools

Cleco®

Inline Floating Spindle Series

Torque Range
2 - 248 Nm
1.5 - 182.9 Ft. Lbs.

Bolt Size
M5 - M16
#10 - 5/8"

- Brushless precision
- Resolver control
- Transducer control
- Memory intelligence



48ESE12ZA

XX	E	S	E	XXX	XXX
Motor 18, 48	Power E-Electric	Connector Air-LB		Output Drive ZA - 1/4" Sq.Dr. 1ZB - 3/8" Sq.Dr. 2ZB - 1/2" Sq.Dr. 3ZB - 3/4" Sq.Dr.	
Tool Style S - Inline					
Max Output Torque (Nm) Under 60 Nm, rounded up to the nearest 1 Nm. Over 60 Nm, rounded to the nearest 5 Nm.					

Base Plate Mounting Dimensions

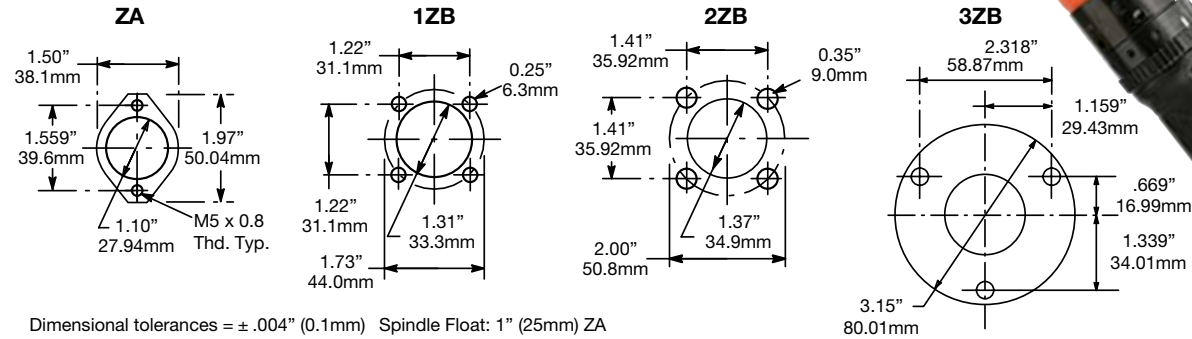

Inline Floating Spindle Model Number	Torque Range		Max. Speed	Weight*		Output Drive Size	Length		Side to Center	
	ft. lbs.	Nm	RPM	lbs.	kg		in.	mm	in.	mm
18ESE06ZA	1.5-4.4	2-6	4000	3.0	1.4	1/4	15.5	394	0.91	23
18ESE12ZA	2.2-8.9	3-12	1820	3.2	1.5	1/4	16.0	406	0.91	23
18ESE17ZA	3.0-12.5	4-17	1290	3.2	1.5	1/4	16.0	406	0.91	23
48ESE12ZA	2.2-8.9	3-12	4000	3.4	1.5	1/4	16.7	425	0.91	23
48ESE271ZB	5.9-19.9	8-27	1820	5.8	2.6	3/8	22.0	559	0.92	23
48ESE361ZB	5.2-26.6	7-36	1290	5.8	2.6	3/8	22.0	559	0.92	23
48ESE602ZB	8.1-42.0	11-57	855	8.4	3.8	1/2	24.4	620	1.10	28
48ESE702ZB	10.3-50.2	14-68	570	8.4	3.8	1/2	24.4	620	1.10	28
48ESE802ZB	12.5-60.5	17-82	450	9.6	4.4	1/2	26.7	678	1.10	31
48ESE1152ZB	18.4-84.8	25-115	320	9.6	4.4	1/2	26.7	678	1.10	31
48ESE1502ZB	22.9-110.6	31-150	245	9.6	4.4	1/2	26.7	678	1.10	31
48ESE1653ZB	24.3-121.7	33-165	220	14.6	6.6	3/4	28.6	726	1.57	40
48ESE2503ZB	36.8-182.9	50-248	145	14.6	6.6	3/4	28.6	726	1.57	40

*Weights are without tool cable or reaction bar if so equipped.

General: All tools must be used with an approved ATG cable and controller.

Standard Equipment: Air-LB Connector. Tool square drives have thru hole output. Tools with Matrix connector available upon request.

Extra Equipment: Std. tool cable 301866-XX, RA swivel cable 301903-XX, Inline swivel cable 301904-XX, Extension cable 301877-XX.

Additional Accessories: See pages 121-129 for additional accessories.



67ES2060Z8

All 67 Series Tools require an isolation transformer (544185PT) for use with Cleco Global Controller.

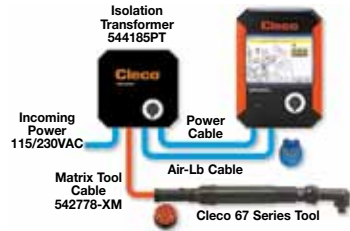

67	E	S	XXXX	XX
Motor 67	Electric			Output Drive Z4 – 1/2" Sq.Dr. Z6 – 3/4" Sq.Dr. Z8 – 1" Sq.Dr.
Tool Style S – Inline				

Max Output Torque (Nm)

Under 60 Nm, rounded up to the nearest 1 Nm.
Over 60 Nm, rounded to the nearest 5 Nm.

Inline Floating Spindle Series

Torque Range	Bolt Size
13 - 2060 Nm	M6 - M36
10 - 1520 Ft. Lbs.	1/4" - 1 1/2"

- Brushless precision
- Resolver control
- Transducer control
- Memory intelligence

67ES Base Plate Mounting Dimensions

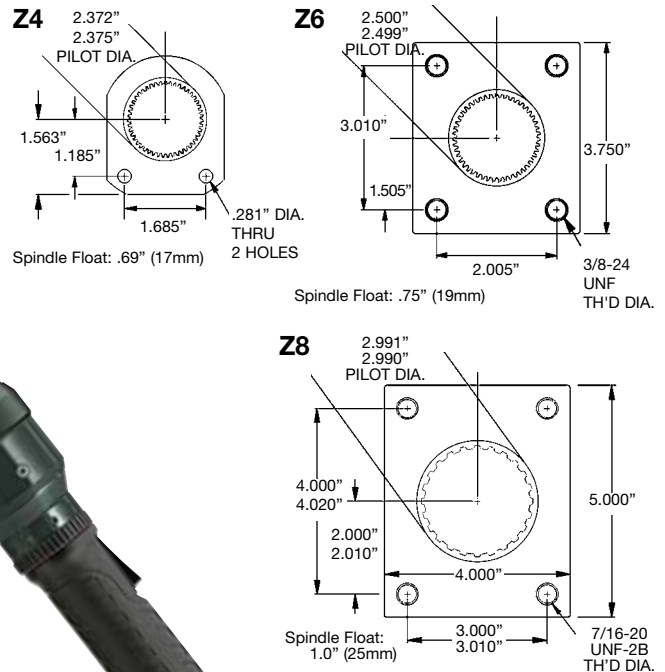

Inline Floating Spindle Model Number	Torque Range		Max. Speed RPM	Weight*		Output Drive Size	Length		Side to Center	
	ft. lbs.	Nm		lbs.	kg		in.	mm	in.	mm
67ES65BZ4	10-47	13-64	535	10.8	4.9	1/2	21.0	533	1.31	33
67ES105BZ4	15-77	21-104	330	10.8	4.9	1/2	21.0	533	1.31	33
67ES135BZ4	20-100	27-135	245	10.8	4.9	1/2	21.0	533	1.31	33
67ES190Z6	28-140	38-190	165	15.6	7.1	3/4	22.0	559	1.31	33
67ES285Z6	42-210	57-285	115	15.6	7.1	3/4	22.0	559	1.31	33
67ES385Z6	57-285	77-386	83	15.6	7.1	3/4	22.0	559	1.31	33
67ES475Z6	70-350	95-475	67	16.0	7.3	3/4	22.4	569	1.31	33
67ES610Z6	90-450	122-610	50	16.0	7.3	3/4	22.4	569	1.31	33
67ES850Z8	125-625	170-848	33	20.0	9.1	1	23.8	605	1.50	38
67ES1050Z8	155-775	210-1050	27	20.0	9.1	1	23.8	605	1.50	38
67ES1670Z8	246-1230	334-1668	17	20.0	9.1	1	23.8	605	1.50	38
67ES2060Z8	304-1520	412-2060	14	20.0	9.1	1	23.8	605	1.50	38

*Weights are without tool cable or reaction bar if so equipped.

Note: All 67 series tools require an isolation transformer (544185PT) for use with Cleco Global Controller.

General: All tools must be used with an approved ATG cable and controller.

Standard Equipment: Matrix Connector; 67ES series – Mounting plate.

Extra Equipment: Std. tool cable 542778-XX, RA swivel cable 544055-XX, Inline swivel cable 544056-XX, Extension cable 542779-XX.

Additional Accessories: See pages 121-129 for additional accessories.

Electric Nutrunners – Corded Transducer Control

Hold & Drive Tools

Cleco®

Hold & Drive Series

Torque Range
 11 - 227 Nm
 8.1 - 167.4 Ft. Lbs.

- Brushless precision
- Resolver control
- Transducer control
- Memory intelligence



48EAE115H

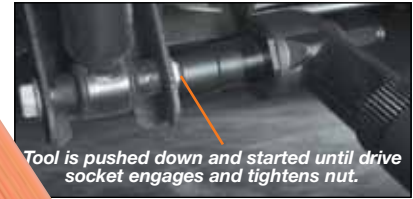
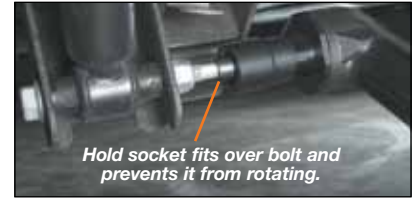

“Hold & Drive” bolts are used with these tools in automotive and truck frame applications. They reduce assembly handling to one person working from one side of the workpiece. The bolt is held stationary by the tool while the nut is tightened from the same side.

Hold & Drive Tool Nomenclature

Socket Nomenclature

48	E	A	E	XXX	H	H	X	XX	X	XX	X
----	---	---	---	-----	---	---	---	----	---	----	---

Motor 48	Electric	Tool Style Air-LB A - Angle	Connector Air-LB	Head Type H-Hold & Drive	Hold & Drive	Socket Style F - Female Hex M - Male Hex T - Torx O - Female Oval	Oval Dim. (length) If socket style =0 (female oval)	Hold Socket (width across flats)
Max Output Torque				Retainer Shaft		Hold Socket (width across flats)		
				3 - 3 1/2"		EA - 1/4		ME - 11mm (7/16")
				4 - 4"		EC - 3/8		MF - 12mm
				5 - 5 3/8"		M5 - 5mm		15 - T15
				6 - 5 7/8"		M6 - 6mm		20 - T20
				9 - 9 1/2"		MA - 7mm		25 - T25
						MB - 8mm (5/16")		30 - T30
						MC - 9mm		40 - T40
						MD - 10mm		45 - T45
								50 - T50

Drive Socket Sizes (surface drive)

EH - 11/16	MG - 13mm	MM - 19mm (3/4")	MS - 25mm
EJ - 13/16	MH - 14mm	MN - 20mm	MT - 26mm
EK - 7/8	MI - 15mm	MO - 21mm	MU - 27mm (1 1/16")
EM - 1	MJ - 16mm (5/8")	MP - 22mm	MX - 30mm (1 3/16")
EO - 1 1/8	MK - 17mm	MQ - 23mm	MZ - 32mm (1 1/4")
	ML - 18mm	MR - 24mm (15/16")	

Note: To order a tool include the Socket Nomenclature with the Tool Nomenclature. Order just the Socket Nomenclature for a complete head assembly. Refer to Parts List for individual socket part numbers.

Hold & Drive Model Number	Torque Range		Free Speed RPM	Length		Weight*		Head Height		Side to Center	
	Ft.Lbs.	Nm		in.	mm	lbs.	kg	in.	mm	in.	mm
48EAE53H	8.1 - 39.1	11 - 53	850	20.2	512	7.9	3.60	2.40	61	1.06	27
48EAE75H	11.1 - 54.6	15 - 74	600	20.2	512	7.9	4.03	2.40	61	1.06	27
48EAE110H	17.0 - 82.6	23 - 112	400	20.2	512	8.9	4.03	2.40	61	1.06	27
48EAE135H	20.7 - 98.8	28 - 134	270	20.6	522	8.9	4.03	2.40	61	1.06	27
48EAE230H	34.7 - 167.4	47 - 227	150	22.2	563	10.6	4.79	2.40	61	1.06	27

*Weights are without tool cable and reaction bar.

General: All tools must be used with an approved ATG cable and controller.

Standard Equipment: Air-LB Connector. Retraction 1" standard for hold bit. Tools with Matrix connector available upon request.

Extra Equipment: Std. tool cable 301866-XX, RA swivel cable 301903-XX, Inline swivel cable 301904-XX, Extension cable 301877-XX.

Additional Accessories: See pages 121-129 for additional accessories.

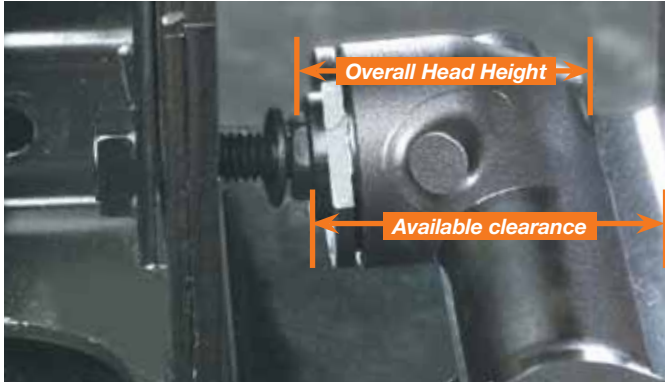

Flush socket tools have plenty of clearance to fit low clearance applications. Electric flush socket tools tighten with much higher accuracy than tools with crowfoot attachment.

Cleco®

Flush Socket Series

Torque Range
4.9 - 230 Nm
3.6 - 169.6 Ft. Lbs.

Bolt Size
M8 - M21
1/2" - 1 3/16"

- Brushless precision
- Resolver control
- Transducer control
- Memory intelligence



Flush Socket Tool Nomenclature



Motor
18
48

Electric

Connector
Air-LB

Tool Style
A – Right Angle

Max Output Torque

F1 16,23, 30 Nm	F3 53, 75, 110 Nm
F2 37, 52 Nm	F4 135, 230 Nm

<60 Nm, rounded up to the nearest 1 Nm. >60 Nm, rounded to the nearest 5 Nm.

Head Type

F1 Head 8–15mm socket capacity
F2 Head 10–15mm socket capacity
F3 Head 13–21mm socket capacity
F4 Head 13–21mm socket capacity

Socket Nomenclature



Flush Socket

- 1 F1
- 2 F2
- 3 F3
- 4 F4

Output Type
0–Standard 1–Fast Lead 2–Magnetic

Extension Length

0 – Flush	4 – 1/2"	8 – 1"
2 – 1/4"	6 – 3/4"	

Socket Size

EC – 3/8	MB – 8mm (5/16)	MJ – 16mm (5/8")
EE – 1/2	MD – 10mm	MK – 17mm
EF – 9/16	ME – 11mm (7/16)	ML – 18mm
EH – 11/16	MF – 12mm	MM – 19mm (3/4")
EJ – 13/16	MG – 13mm	MN – 20mm
	MH – 14mm	MO – 21mm
	MI – 15mm	

X Dimension For Flush Socket

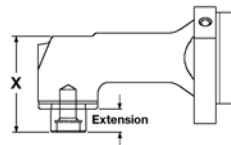

Head	in.	mm	Socket Size Range
F1	1.54	39	8–15mm
F2	1.69	43	10–15mm
F3	2.32	59	13–21mm
F4	2.4	61	17–21mm

Note: To order a tool include the Socket Nomenclature with the Tool Nomenclature. Order just the Socket Nomenclature for a complete head assembly. Refer to Parts List for individual socket part numbers.

Flush Socket Model Number	Head Type	Torque Range		Free Speed RPM	Weight*		Length		Anglehead			
		ft. lbs.	Nm		lbs.	kg	in.	mm	Side to Center		Height	
									in.	mm	in.	mm
18EAE16F1	F1	3.6-11.8	4.9-16	1225	4.4	2.00	16.0	406	0.55	14	1.54	39
18EAE23F1	F1	3.4-17.0	4.6-23	860	4.4	2.00	16.0	406	0.55	14	1.54	39
18EAE30F1	F1	4.4-22.1	6.0-30	655	4.4	2.00	16.0	406	0.55	14	1.54	39
48EAE37F2	F2	5.9-27.3	8.0-37	1225	5.4	2.43	18.7	474	0.67	17	1.69	43
48EAE52F2	F2	8.1-38.3	11-52	860	5.4	2.43	18.7	474	0.67	17	1.69	43
48EAE53F3	F3	8.1-39.0	11-53	850	6.0	2.74	20.0	509	0.87	22	2.32	59
48EAE75F3	F3	11.1-55.3	15-75	600	6.0	2.74	20.0	509	0.87	22	2.32	59
48EAE110F3	F3	17.0-81.1	23-110	400	7.4	3.38	20.5	521	0.87	22	2.32	59
48EAE135F4	F4	19.9-99.5	27-135	270	8.9	4.03	20.6	522	1.06	27	2.40	61
48EAE230F4	F4	34.7-169.6	47-230	150	10.6	4.79	22.2	563	1.06	27	2.40	61

*Weights are without tool cable or reaction bar if so equipped.

General: All tools must be used with an approved ATG cable and controller.

Standard Equipment: Air-LB Connector.

Tools with Matrix connector available upon request.

Extra Equipment: Std. tool cable 301866-XX, RA swivel cable 301903-XX, Inline swivel cable 301904-XX, Extension cable 301877-XX.

Additional Accessories: See pages 121-129 for additional accessories.

Electric Nutrunners – Corded Transducer Control

Tube Nut Tools



Tube Nut Series

Torque Range
10 - 40 Nm
7.4 - 29.5 Ft. Lbs.

Bolt Size
M6 - M10
1/4" - 3/8"

- Brushless precision
- Resolver control
- Transducer control
- Memory intelligence

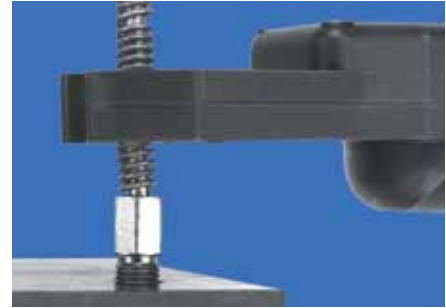
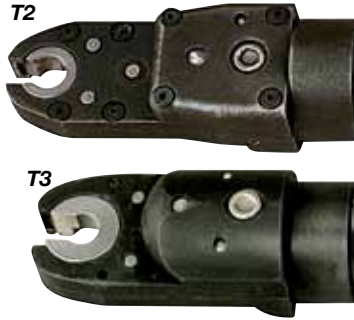

The 48ET tube nut wrench alternates the direction of rotation each time the lever is actuated. When rotating in reverse, the socket will stop at the open position.

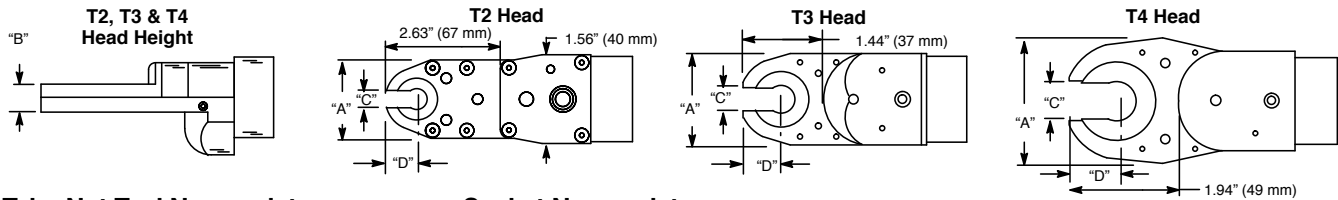

Tube Nut Tool Nomenclature

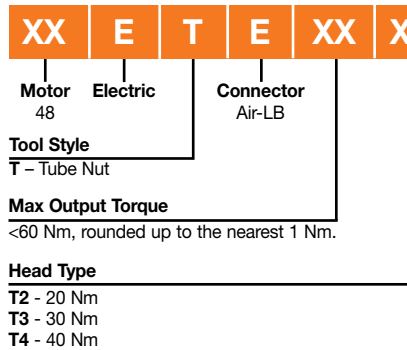

Socket Nomenclature

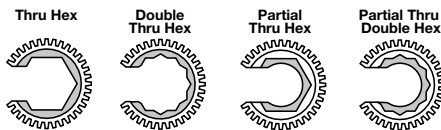
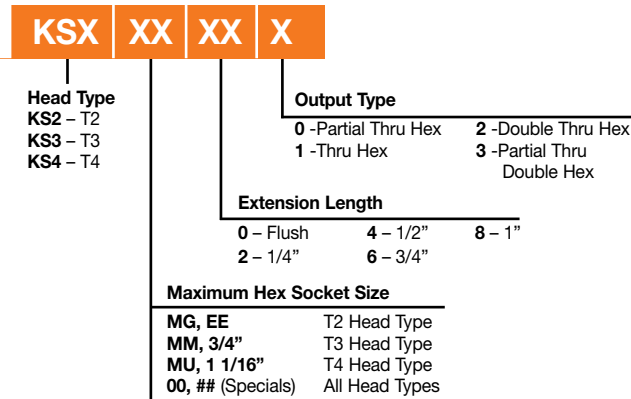

Socket Sizes

EA - 1/4"	M5 - 5mm	MH - 14mm	MP - 22mm
EC - 3/8	M6 - 6mm	MI - 15mm	MQ - 23mm
EE - 1/2	MA - 7mm	MJ - 16mm (5/8)	MR - 24mm (15/16)
EF - 9/16	MB - 8mm (5/16)	MK - 17mm	MS - 25mm
EH - 11/16	MD - 10mm	ML - 18mm	MT - 26mm
EJ - 13/16	ME - 11mm (7/16)	MM - 19mm (3/4)	MU - 27mm (1 1/16)
EK - 7/8	MF - 12mm	MN - 20mm	
EM - 1	MG - 13mm	MO - 21mm	

Note: To order a tool include the Socket Nomenclature with the Tool Nomenclature.

Order T2XXXX for a complete head assembly (i.e. T2MF02)

To order individual sockets, use a "KS" prefix (i.e. KS2EA01 for a T2 1/4", Flush, Thru Hex socket.)

Tube Nut	Max. Drive Size	Torque Range		Free Speed	Weight*		Length		Head							
		Ft.Lbs.	Nm		RPM	lbs.	kg	in.	mm	A Width		B Blade Ht.		C Opening		D End/Cntr.
48ETE20T2	1/2"	7.4-14.8	10-20	1425	4.4	2.0	16.9	430	1.42	36	0.55	14	0.28	7	0.53	13
48ETE30T3	3/4"	11.1-22.1	15-30	1030	4.5	2.0	16.6	422	1.65	42	0.59	15	0.475	13	0.73	19
48ETE40T4	1 1/16"	14.8-29.5	20-40	770	5.3	2.3	17.9	454	2.36	60	0.59	15	0.675	18	0.93	24

*Weights are without tool cable and reaction bar.

General: All tools must be used with an approved ATG cable and controller.

Standard Equipment: Air-LB Connector.

Tools with Matrix connector available upon request.

Extra Equipment: Std. tool cable 301866-XX, RA swivel cable 301903-XX, Inline swivel cable 301904-XX, Extension cable 301877-XX.

Additional Accessories: See pages 121-129 for additional accessories.

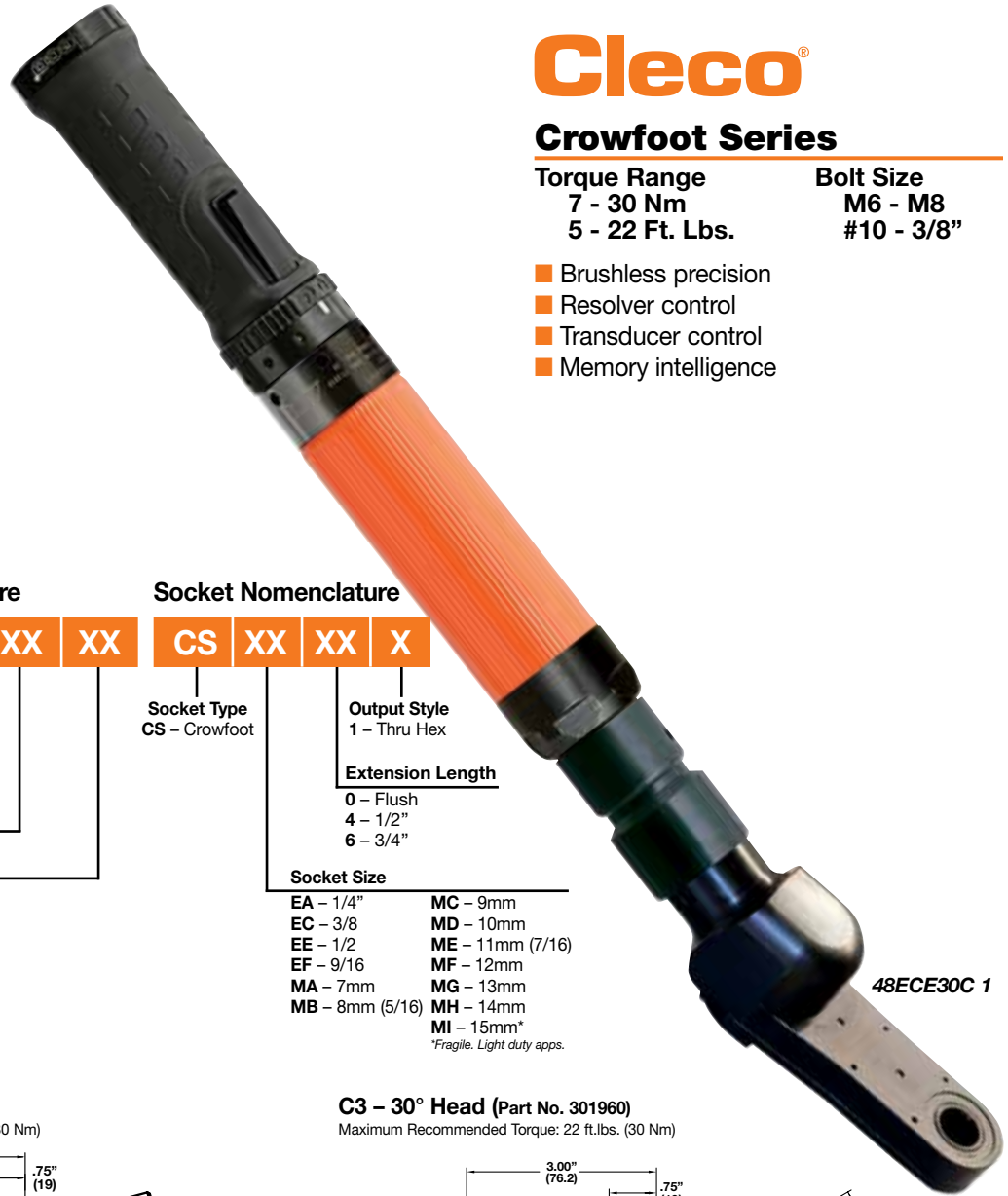

Cleco®

Crowfoot Series

Torque Range	Bolt Size
7 - 30 Nm	M6 - M8
5 - 22 Ft. Lbs.	#10 - 3/8"

- Brushless precision
- Resolver control
- Transducer control
- Memory intelligence

Crowfoot Tool Nomenclature

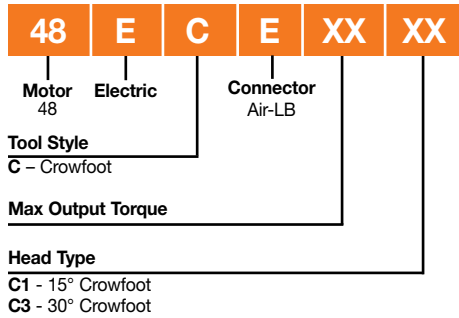

Socket Nomenclature



C1 - 15° Head (Part No. 301959)

Maximum Recommended Torque: 22 ft.lbs. (30 Nm)

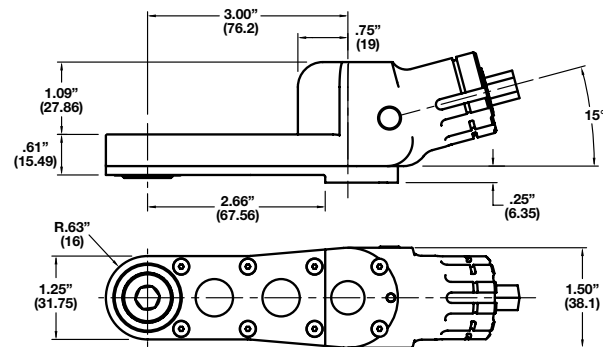

C3 - 30° Head (Part No. 301960)

Maximum Recommended Torque: 22 ft.lbs. (30 Nm)

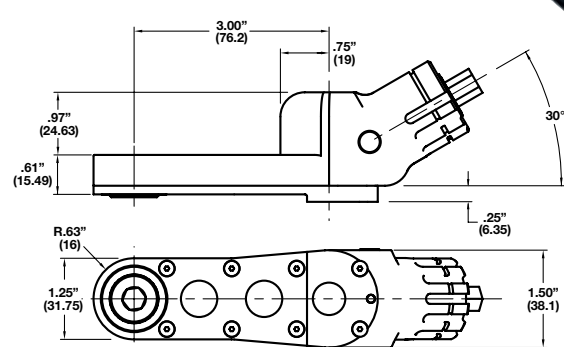

Note: To order a tool include the Socket Nomenclature with the Tool Nomenclature. To order individual sockets, use "CS" prefix before the required socket. (i.e. CSEA01 for a 1/4", flush, thru hex socket.)

Crowfoot		Torque Range		Free Speed	Weight*		Length	
Model Number		ft. lbs.	Nm	RPM	lbs.	kg	in.	mm
15° Head	30° Head							
48ECE30C1	48ECE30C3	5.2-22.1	10.5-30	860	5.5	2.3	20.5	521

*Weights are without tool cable and reaction bar.

General: All tools must be used with an approved ATG cable and controller.

Standard Equipment: Air-LB Connector.

Tools with Matrix connector available upon request.

Extra Equipment: Std. tool cable 301866-XX, RA swivel cable 301903-XX, Inline swivel cable 301904-XX, Extension cable 301877-XX.

Additional Accessories: See pages 121-129 for additional accessories.

Electric Nutrunners – Coded Transducer Control

Right Angle Floating Spindle Tools



Right Angle Floating Spindle Series

Torque Range
5.1 - 255 Nm
3.7 - 188.1 Ft. Lbs.

Bolt Size
M7 - M18
1/4" - 3/4"

- Brushless precision
- Resolver control
- Transducer control
- Memory intelligence



Right Angle Floating Spindle Tool Nomenclature

XX	E	A	X	XXX	XX	X	X
Motor 18 48 67	Electric	Connector E - Air-LB		Square Drive 3 - 3/8" (S1, S2) 4 - 1/2" (S3, S4) 6 - 3/4" (S4)	Extension Length 1 -1.13" (S1), 1.00" (S2 & S3), 1.25" (S4) 2 -2.13" (S1), 3.00" (S2), 2.5" (S4 1/2" Dr.) 5 -5.13" (S2), 4.25" (S4) 6 - 6.0" (S4 1/2" Dr.), 7.0" (S4 3/4" Dr.) 11 - 11.0" (S4 3/4" Dr.)		
Tool Style A - Right Angle				Tool Termination S1 Sliding (Floating) Spindle S3 Sliding (Floating) Spindle S2 Sliding (Floating) Spindle S4 Sliding (Floating) Spindle			
Max Output Torque S1 Head - 16, 23, or 30 Nm S2 Head - 37 or 52 Nm S3 Head - 53, 75, 95, or 110 Nm S4 Head - 135 or 230 Nm (48 series) S4 Head - 150, 185, 210, 235 or 255 Nm (67 series)							

All 67 Series Tools require an isolation transformer (544185PT) for use with Cleco Global Controller.

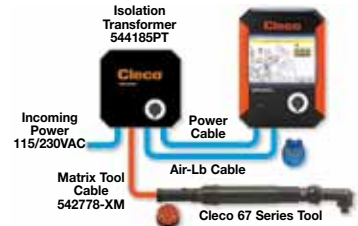

Right Angle Floating Spindle Model Number	Torque Range		Max. Speed RPM	Weight*		Output Drive Size	Length		Side to Center	
	ft. lbs.	Nm		lbs.	kg		in.	mm	in.	mm
18EAE16S131	3.7-11.8	5.1-16	1225	4.4	2.00	3/8"	16.0	406	0.55	14
18EAE23S131	5.3-16.9	7.2-23	860	4.4	2.00	3/8"	16.0	406	0.55	14
18EAE30S131	4.4-22.1	6.0-30	655	4.4	2.00	3/8"	16.0	406	0.55	14
48EAE37S231	5.9-27.2	8.0-37	1225	5.4	2.43	3/8"	18.7	474	0.67	17
48EAE52S231	8.1-38.3	11-52	860	5.4	2.43	3/8"	18.7	474	0.67	17
48EAE53S341	8.1-39.1	11-53	850	6.0	2.74	1/2"	20.0	509	0.87	22
48EAE75S341	11.0-55.3	15-75	600	6.0	2.74	1/2"	20.0	509	0.87	22
48EAE95S341	14.7-70.0	20-95	460	7.4	3.38	1/2"	20.5	521	0.87	22
48EAE110S341	16.9-81.1	23-110	400	7.4	3.38	1/2"	20.5	521	0.87	22
48EAE135S461	20.6-99.5	28-135	270	8.9	4.03	3/4"	20.6	522	1.06	27
48EAE230S461	34.6-169.6	47-230	150	10.6	4.79	3/4"	22.2	563	1.06	27
67EA150S461	22.1-110.6	30-150	210	12.9	5.90	3/4"	25.8	655	1.03	26
67EA185S461	27.3-136.3	37-185	170	12.9	5.90	3/4"	25.8	655	1.03	26
67EA210S461	31.0-154.8	42-210	155	12.9	5.90	3/4"	25.8	655	1.03	26
67EA235S461	33.9-169.6	46-230	135	12.9	5.90	3/4"	25.8	655	1.03	26
67EA255S461	40.6-188.1	55-255	115	12.9	5.90	3/4"	25.8	655	1.03	26

*Weights are without tool cable and mounting plate.

Note: All 67 series tools require an isolation transformer (544185PT) for use with Cleco Global Controller.

General: All tools must be used with an approved ATG cable and controller.

Standard Equipment: 18/48 tools; Air-LB Connector; Mounting plate.

Tools with Matrix connector available upon request.
67 tools; Matrix Connector; Mounting plate

Extra Equipment: 18/48 tools; Std. tool cable 301866-XX, RA swivel cable 301903-XX, Inline swivel cable 301904-XX, Extension cable 301877-XX.
67 tools; Std. tool cable 542778-XX, RA swivel cable 544055-XX, Inline swivel cable 544056-XX, Extension cable 542779-XX.

Additional Accessories: See pages 121-129 for additional accessories.

18EA, 48EA & 67EA Floating Spindle Angle Heads

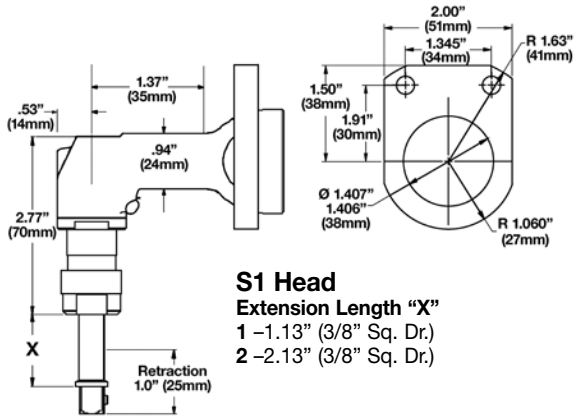

S1 Head
 Extension Length "X"
 1 -1.13" (3/8" Sq. Dr.)
 2 -2.13" (3/8" Sq. Dr.)

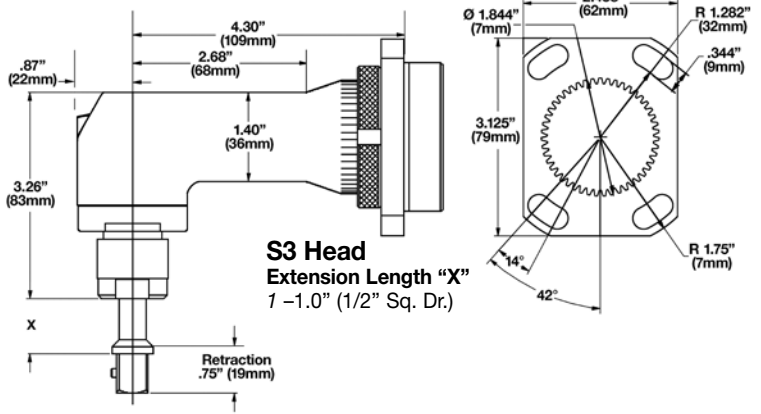

S3 Head
 Extension Length "X"
 1 -1.0" (1/2" Sq. Dr.)

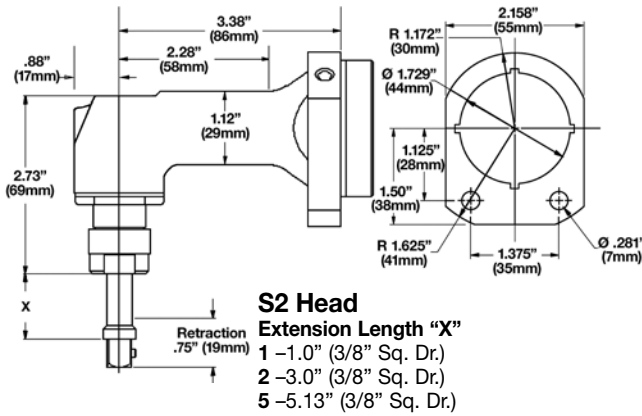

S2 Head
 Extension Length "X"
 1 -1.0" (3/8" Sq. Dr.)
 2 -3.0" (3/8" Sq. Dr.)
 5 -5.13" (3/8" Sq. Dr.)

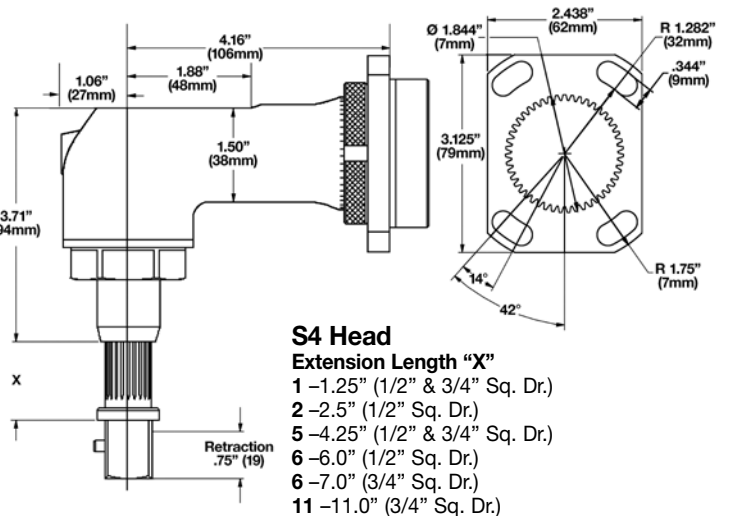

S4 Head
 Extension Length "X"
 1 -1.25" (1/2" & 3/4" Sq. Dr.)
 2 -2.5" (1/2" Sq. Dr.)
 5 -4.25" (1/2" & 3/4" Sq. Dr.)
 6 -6.0" (1/2" Sq. Dr.)
 6 -7.0" (3/4" Sq. Dr.)
 11 -11.0" (3/4" Sq. Dr.)

How To Build A DC Fastening System

mPro400GC-E & mPro400GC-I

Building a DC System for **Quality Critical** applications is as simple as 1, 2, 3!

1. Choose a common system to the right.
2. Select the correct components below.
3. Order your System!

(Refer to Pages 26-27 to build a mPro400GC-M/GC-P/GC-S system.)

Controller (Page 114)



Corded Tool, Transducer Control (Pages 32-44)



Corded Tool, Current Control (Pages 48-58)



Cable (Page 122)



Input Accessories (Page 124)



Output Accessories (Page 124)



Input Accessory Cables (Page 124)



Output Accessory Cables (Page 124)



Input to Input Accessory Cables (Page 124)



Isolation Transformer (Page 121)



→
Add or delete components as required.

Model/Part Number	One Corded CC Tool (18/48C_E) & 8 Pos. Socket Tray One Corded CC Tool (18/48E_E) & Annunciator One Corded Tool (18/48E_E) & Torque Selector One Corded Tool (67E_XXX) One Corded Tool (18/48E_E)							
	1	1	1	1	1	1	1	1
mPro400GC-E (Transducer Control)	1	1	1	1				1
mPro400GC-I (Current Control)					1	1		
18/48E_EXXX	1		1	1				1
67E_XXX		1						
18/48C_EXXX					1	1		
Tool Cable - 301866-XM (Air-Lb)	1		1	1	1	1	1	1
Tool Cable - 542778-XM (Matrix)		1						
Extension Cable - 301877-XM (If Required) (Air-Lb)								
Extension Cable - 542779-XM (If Required) (Matrix)								
542977-X Torque Selector Switch			1					1
542978-X Socket Tray								
544241PT - 4-pos Bit & Socket Tray (cable included)								
544242PT - 8-pos Bit & Socket Tray (cable included)							1	
54297X - Start/Stop Switches								1
542976-1 Annunciator				1				
544237-1M Input Accessory Cable			1					1
544237-5M Input Accessory Cable								
544237-10M Input Accessory Cable								
544237-15M Input Accessory Cable								
544238-1M Output Accessory Cable				1				
544238-5M Output Accessory Cable								
544238-10M Output Accessory Cable								
544238-15M Output Accessory Cable								
542986-X - Input to Input Accessory Cable								1
544185PT		1						

Electric Nutrunners – Corded Current Control

Right Angle Tools

Cleco®

Right Angle Series

Torque Range
2 - 230 Nm
1.5 - 170 Ft. Lbs.

Bolt Size
M5 - M16
#10 - 5/8"

- Brushless precision
- Resolver control
- Memory intelligence

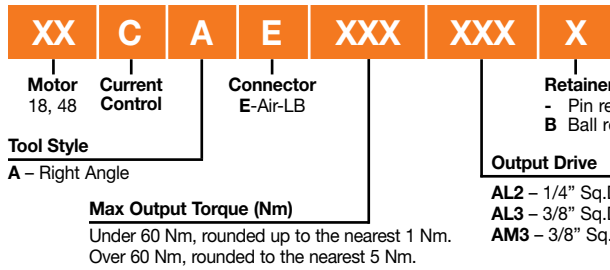

Right Angle Model Number	Torque Range		Max. Speed RPM	Weight*		Output Drive Size	Length		Anglehead					
	ft. lbs.	Nm		lbs.	kg		in.	mm	Side to Center		Height			
									in.	mm	in.	mm	in.	mm
18CAE08AL2	1.5-5.9	2-8	3000	2.9	1.3	1/4"	13.6	345	0.51	13	1.4	36		
18CAE15AM3	3.0-11.1	4-15	1300	3.3	1.5	3/8"	14.8	376	0.59	15	1.6	41		
18CAE22AM3	3.7-16.2	5-22	920	3.3	1.5	3/8"	14.8	376	0.59	15	1.6	41		
18CAE28AM3	4.4-20.7	6-28	700	3.3	1.5	3/8"	14.8	376	0.59	15	1.6	41		
48CAE15AL3	2.2-11.1	3-15	2855	3.8	1.7	3/8"	15.7	398	0.59	15	1.6	41		
48CAE28AL3	4.4-20.7	6-28	1300	4.1	1.9	3/8"	16.2	410	0.59	15	1.6	41		
48CAE41AM3	6.6-30.2	9-41	1090	4.3	2.0	3/8"	17.3	440	0.75	19	1.9	48		
48CAE58AM3	8.9-42.8	12-58	770	4.3	2.0	3/8"	17.3	440	0.75	19	1.9	48		
48CAE58AM4	8.9-42.8	12-58	770	4.3	2.0	1/2"	17.3	440	0.75	19	1.9	48		
48CAE90AH4	13.3-64.2	18-87	515	6.6	3.0	1/2"	18.5	470	0.81	21	2.3	58		
48CAE105AH4	15.5-76.7	21-104	340	6.6	3.0	1/2"	18.5	470	0.81	21	2.3	58		
48CAE135MH4	19.9-98.1	27-133	265	7.3	3.3	1/2"	19.1	485	0.94	24	2.4	61		
48CAE175AX6	26.6-129.8	36-176	190	10.2	4.6	3/4"	21.6	549	1.06	27	2.7	69		
48CAE230AX6	33.9-169.6	46-230	145	10.2	4.6	3/4"	21.6	549	1.06	27	2.7	69		

*Weights are without tool cable and reaction bar.

General: All tools must be used with an approved ATG cable and controller.

Standard Equipment: Air-LB Connector. Ball retainer optional.

Extra Equipment: Std. tool cable 301866-XX, RA swivel cable 301903-XX, Inline swivel cable 301904-XX, Extension cable 301877-XX.

Additional Accessories: See pages 121-129 for additional accessories.

Electric Nutrunners – Corded Current Control

Inline Non-Floating Spindle Tools

Cleco®



Cleco®

Inline Non-Floating Series

Torque Range
2 - 150 Nm
1.5 - 113 Ft. Lbs.

Bolt Size
M5 - M14
#10 - 5/8"

- Brushless precision
- Resolver control
- Memory intelligence

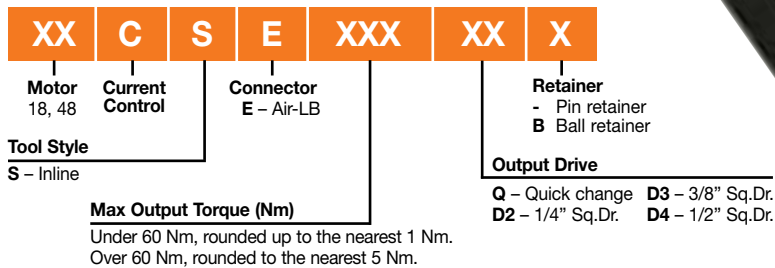

Inline Non-Floating Model Number	Torque Range		Max. Speed RPM	Weight*		Output Drive Size	Length		Side to Center	
	ft. lbs.	Nm		lbs.	kg		in.	mm	in.	mm
18CSE06Q	1.5-4.4	2-6	4000	2.5	1.1	1/4" Hex	12.3	312	0.91	23
18CSE06D2	1.5-4.4	2-6	4000	2.5	1.1	1/4"	11.8	300	0.91	23
18CSE12Q	2.2-8.9	3-12	1820	2.7	1.2	1/4" Hex	13.0	330	0.91	23
18CSE12D3	2.2-8.9	3-12	1820	2.7	1.2	3/8"	12.4	315	0.91	23
18CSE17Q	3.0-12.5	4-17	1290	2.7	1.2	1/4" Hex	13.0	330	0.91	23
18CSE17D3	3.0-12.5	4-17	1290	2.7	1.2	3/8"	12.4	315	0.91	23
18CSE22D3	3.7-16.2	5-22	985	2.7	1.2	3/8"	12.4	315	0.91	23
18CSE31D3	5.2-22.9	7-31	695	2.7	1.2	3/8"	12.4	315	0.91	23
48CSE12Q	2.2-8.9	3-12	4000	3.0	1.4	1/4" Hex	13.5	343	0.91	23
48CSE12D2	2.2-8.9	3-12	4000	3.0	1.4	1/4"	13.0	330	0.91	23
48CSE25D3	4.4-18.4	6-25	1820	3.2	1.5	3/8"	13.6	345	0.91	23
48CSE36D3	5.9-26.6	8-36	1290	3.2	1.5	3/8"	13.6	345	0.91	23
48CSE48D3	7.4-35.4	10-48	985	3.3	1.5	3/8"	13.8	351	0.91	23
48CSE65D4	9.6-47.9	13-65	750	5.3	2.4	1/2"	16.6	420	1.13	29
48CSE90D4	14.0-66.4	19-90	510	5.6	2.5	1/2"	17.1	435	1.13	29
48CSE125D4	19.2-92.2	26-125	360	5.6	2.5	1/2"	17.1	435	1.13	29
48CSE150D4	22.9-110.6	31-150	240	5.6	2.5	1/2"	17.1	435	1.13	29

*Weights are without tool cable and reaction bar.

General: All tools must be used with an approved ATG cable and controller.

Standard Equipment: Air-LB Connector; Dead Handle is included with 18CSE12Q and 18CSE12D3. Reaction bar is included with inline tools with output torques of 17-150 Nm. Ball retainer optional.

Extra Equipment: Std. tool cable 301866-XX, RA swivel cable 301903-XX, Inline swivel cable 301904-XX, Extension cable 301877-XX.

Mounting Plates: 543231 - (all with exception of listed below)

543235 - 18ES06Q/D2, 48ES12Q/D2

49087108 - 48ES65D4, 48ES90D4, 48ES125D4, & 48ES150D4.

Additional Accessories: See pages 121-129 for additional accessories.

Electric Nutrunners – Corded Current Control

Pistol Grip Tools

Cleco®

Pistol Grip Series

Torque Range
2 - 150 Nm
1.5 - 110 Ft. Lbs.

Bolt Size
M5 - M14
#10 - 5/8"

- Brushless precision
- Resolver control
- Memory intelligence

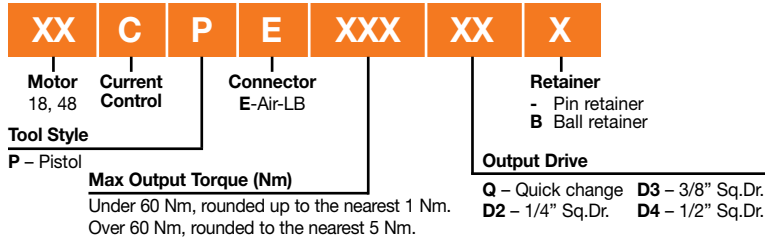

Pistol Grip Model Number	Torque Range		Max. Speed RPM	Weight*		Output Drive Size	Length		Side to Center	
	ft. lbs.	Nm		lbs.	kg		in.	mm	in.	mm
18CPE06Q	1.5-4.4	2-6	4000	2.2	1.0	1/4" Hex	7.0	178	0.84	21
18CPE06D2	1.5-4.4	2-6	4000	2.2	1.0	1/4"	6.5	165	0.84	21
18CPE12Q	2.2-8.9	3-12	1820	2.4	1.1	1/4" Hex	7.7	196	0.84	21
18CPE12D3	2.2-8.9	3-12	1820	2.4	1.1	3/8"	7.2	183	0.84	21
18CPE17Q	3.0-12.5	4-17	1290	2.4	1.1	1/4" Hex	7.7	196	0.84	21
18CPE17D3	3.0-12.5	4-17	1290	2.4	1.1	3/8"	7.2	183	0.84	21
18CPE22D3	3.7-16.2	5-22	985	2.4	1.1	3/8"	7.2	183	0.84	21
18CPE31D3	5.2-22.9	7-31	695	2.4	1.1	3/8"	7.2	183	0.84	21
48CPE12Q	2.2-8.9	3-12	4000	2.7	1.2	1/4" Hex	8.3	211	0.84	21
48CPE12D2	2.2-8.9	3-12	4000	2.7	1.2	1/4"	7.7	196	0.84	21
48CPE25D3	4.4-18.4	6-25	1820	2.9	1.3	3/8"	8.4	213	0.84	21
48CPE36D3	5.9-26.6	8-36	1290	2.9	1.3	3/8"	8.4	213	0.84	21
48CPE48D3	7.4-35.4	10-48	985	3.0	1.4	3/8"	8.6	218	0.84	21
48CPE65D4	9.6-47.9	13-65	750	5.0	2.3	1/2"	10.8	274	1.1	28
48CPE90D4	14.0-66.4	19-90	510	5.3	2.4	1/2"	11.3	287	1.1	28
48CPE125D4	19.2-92.2	26-125	360	5.3	2.4	1/2"	11.3	287	1.1	28
48CPE150D4	22.9-110.6	31-150	240	5.3	2.4	1/2"	11.3	287	0.9	23

*Weights are without tool cable and reaction bar.

General: All tools must be used with an approved ATG cable and controller.

Standard Equipment: Air-LB Connector; Suspension Bail; Dead Handle is included with 18CPE12Q & 18CPE12D3. Reaction bar is included with pistol tools with output torques of 17-150 Nm. Ball retainer optional.

Extra Equipment: Std. tool cable 301866-XX, RA swivel cable 301903-XX, Inline swivel cable 301904-XX, Extension cable 301877-XX.

Additional Accessories: See pages 121-129 for additional accessories.

Electric Nutrunners – Corded Current Control

Push-to-Start Pistol Grip/Inline Tools

Cleco®



18CPE06QP



18CSE06QP

Cleco®

Push-to-Start Series

Torque Range
2 - 12 Nm
1.5 - 8.9 Ft. Lbs.

Bolt Size
M5 - M6
#10 - 1/4"

- Brushless precision
- Resolver control
- Memory intelligence

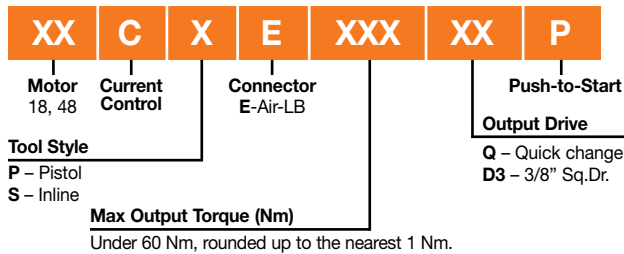

Push-to-Start Model Number	Torque Range		Max. Speed RPM	Weight*		Output Drive Size	Length		Side to Center	
	ft. lbs.	Nm		lbs.	kg		in.	mm	in.	mm
18CPE06QP	1.5-4.4	2-6	4000	2.66	1.19	1/4" Hex	9.35	238	0.84	21
18CPE06D3P	1.5-4.4	2-6	4000	2.66	1.19	3/8"	8.8	224	0.84	21
18CPE12QP	2.2-8.9	3-12	1820	2.83	1.27	1/4" Hex	9.35	196	0.84	21
18CPE12D3P	2.2-8.9	3-12	1820	2.83	1.27	3/8"	8.8	224	0.84	21
18CSE06QP	1.5-4.4	2-6	4000	2.93	1.31	1/4" Hex	14.75	375	0.91	23
18CSE06D3P	1.5-4.4	2-6	4000	2.93	1.31	3/8"	14.20	360	0.91	23
18CSE12QP	2.2-8.9	3-12	1820	3.10	1.40	1/4" Hex	14.75	375	0.91	23
18CSE12D3P	2.2-8.9	3-12	1820	3.10	1.40	3/8"	14.20	360	0.91	23

*Weights are without tool cable and reaction bar.

General: All tools must be used with an approved ATG cable and controller.

Standard Equipment: Air-LB Connector; Suspension Bail on pistol models; Dead Handle (301857) is included with 18CPE12Q & 18CPE12D3.

Extra Equipment: Std. tool cable 301866-XX, RA swivel cable 301903-XX, Inline swivel cable 301904-XX, Extension cable 301877-XX.

Additional Accessories: See pages 121-129 for additional accessories.

Electric Nutrunners – Corded Current Control

Inline Floating Spindle Tools

Cleco®

Inline Floating Spindle Series

Torque Range
2 - 248 Nm
1.5 - 182.9 Ft. Lbs.

Bolt Size
M5 - M16
#10 - 5/8"

- Brushless precision
- Resolver control
- Memory intelligence



18CSE12ZA

XX	C	S	E	XXX	XXX
Motor 18, 48	Current Control	Connector E-Air-LB		Output Drive	
Tool Style S - Inline				ZA - 1/4" Sq.Dr. 1ZB - 3/8" Sq.Dr. 2ZB - 1/2" Sq.Dr. 3ZB - 3/4" Sq.Dr.	
Max Output Torque (Nm)					
Under 60 Nm, rounded up to the nearest 1 Nm. Over 60 Nm, rounded to the nearest 5 Nm.					

Base Plate Mounting Dimensions

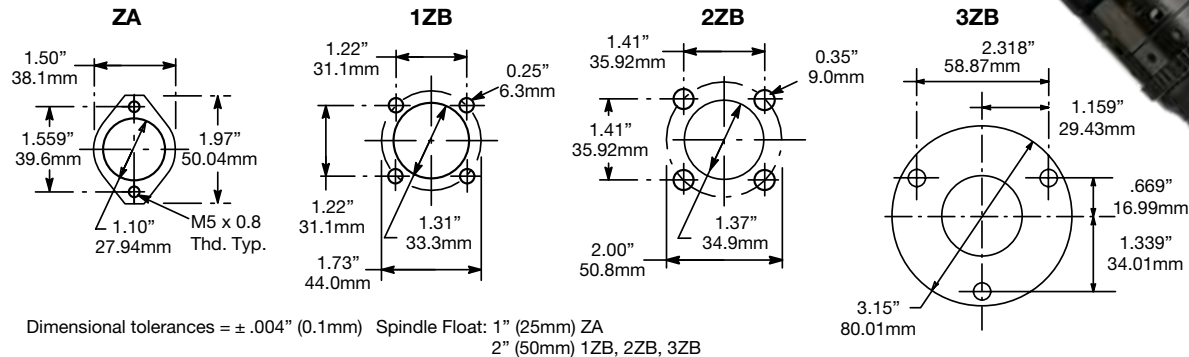

Inline Floating Spindle	Torque Range		Max. Speed	Weight*		Output Drive Size	Length		Side to Center	
	ft. lbs.	Nm		RPM	lbs.		kg	in.	mm	in.
18CSE06ZA	1.5-4.4	2-6	4000	3.0	1.4	1/4	15.5	394	0.91	23
18CSE12ZA	2.2-8.9	3-12	1820	3.2	1.5	1/4	16.0	406	0.91	23
18CSE17ZA	3.0-12.5	4-17	1290	3.2	1.5	1/4	16.0	406	0.91	23
48CSE12ZA	2.2-8.9	3-12	4000	3.4	1.5	1/4	16.7	425	0.91	23
48CSE271ZB	5.9-19.9	8-27	1820	5.8	2.6	3/8	22.0	559	0.92	23
48CSE361ZB	5.2-26.6	7-36	1290	5.8	2.6	3/8	22.0	559	0.92	23
48CSE602ZB	8.1-42.0	11-57	855	8.4	3.8	1/2	24.4	620	1.10	28
48CSE702ZB	10.3-50.2	14-68	570	8.4	3.8	1/2	24.4	620	1.10	28
48CSE802ZB	12.5-60.5	17-82	450	9.6	4.4	1/2	26.7	678	1.10	31
48CSE1152ZB	18.4-84.8	25-115	320	9.6	4.4	1/2	26.7	678	1.10	31
48CSE1502ZB	22.9-110.6	31-150	245	9.6	4.4	1/2	26.7	678	1.10	31
48CSE1653ZB	24.3-121.7	33-165	220	14.6	6.6	3/4	28.6	726	1.57	40
48CSE2503ZB	36.8-182.9	50-248	145	14.6	6.6	3/4	28.6	726	1.57	40

*Weights are without tool cable or reaction bar if so equipped.

General: All tools must be used with an approved ATG cable and controller.

Standard Equipment: Air-LB Connector.

Tool square drives have thru hole output.

Extra Equipment: Std. tool cable 301866-XX, RA swivel cable 301903-XX, Inline swivel cable 301904-XX, Extension cable 301877-XX.

Additional Accessories: See pages 121-129 for additional accessories.



Cleco®

Hold & Drive Series

Torque Range
 11 - 227 Nm
 8.1 - 167.4 Ft. Lbs.

- Brushless precision
- Resolver control
- Memory intelligence

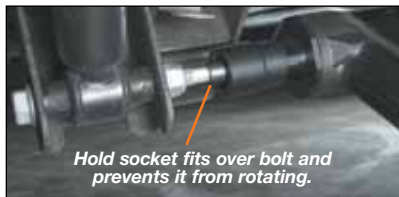

“Hold & Drive” bolts are used with these tools in automotive and truck frame applications. They reduce assembly handling to one person working from one side of the workpiece. The bolt is held stationary by the tool while the nut is tightened from the same side.



Hold & Drive Tool Nomenclature

48	C	A	E	XXX	H
Motor 48	Current Control	Connector E – Air-LB	Head Type H-Hold & Drive	Hold & Drive	
Tool Style		Retainer Shaft			
A – Right Angle		3 - 3 1/2" 4 - 4" 5 - 5 3/8" 6 - 5 7/8" 9 - 9 1/2"			
Max Output Torque					

Drive Socket Sizes (surface drive)

EH – 11/16	MH – 14mm	MN – 20mm	MS – 25mm
EJ – 13/16	MI – 15mm	MO – 21mm	MT – 26mm
EK – 7/8	MJ – 16mm (5/8")	MP – 22mm	MU – 27mm (1 1/16")
EM – 1	MK – 17mm	MQ – 23mm	MX – 30mm (1 3/16")
EO – 1 1/8	ML – 18mm	MR – 24mm (15/16")	MZ – 32mm (1 1/4")
MG – 13mm	MM – 19mm (3/4")		

Head Assembly Nomenclature

H	X	XX	X	XX	X
Socket Style F – Female Hex M – Male Hex T – Torx O – Female Oval	Oval Dim. (length) If socket style =0 (female oval)		Hold Socket (width across flats)		
		EA - 1/4	15 – T15		
		EC - 3/8	20 – T20		
		M5 - 5mm	25 – T25		
		M6 - 6mm	30 – T30		
		MA - 7mm	40 – T40		
		MB - 8mm (5/16")	50 – T50		
		MC - 9mm			
		MD - 10mm			
		ME - 11mm (7/16")			
		MF - 12mm			

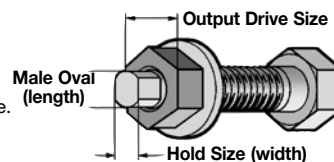

Note: To order a tool include the Socket Nomenclature with the Tool Nomenclature. Order just the Socket Nomenclature for a complete head assembly. Refer to Parts List for individual socket part numbers.

Hold & Drive Model Number	Torque Range		Free Speed RPM	Length		Weight*		Head Height		Side to Center	
	Ft.Lbs.	Nm		in.	mm	lbs.	kg	in.	mm	in.	mm
48CAE53H	8.1 – 39.8	11 – 54	850	20.2	512	7.9	3.60	2.40	61	1.06	27
48CAE75H	11.1 – 56.8	15 – 77	600	20.2	512	7.9	4.03	2.40	61	1.06	27
48CAE110H	17.0 – 85.6	23 – 115	400	20.2	512	8.9	4.03	2.40	61	1.06	27
48CAE135H	20.7 – 101.8	28 – 135	270	20.6	522	8.9	4.03	2.40	61	1.06	27
48CAE230H	34.7 – 169.6	47 – 230	150	22.2	563	10.6	4.79	2.40	61	1.06	27

*Weights are without tool cable or reaction bar if so equipped.

General: All tools must be used with an approved ATG cable and controller.

Standard Equipment: Air-LB Connector. Retraction 1" standard for hold bit.

Extra Equipment: Std. tool cable 301866-XX, RA swivel cable 301903-XX, Inline swivel cable 301904-XX, Extension cable 301877-XX.

Additional Accessories: See pages 121-129 for additional accessories.

Electric Nutrunners – Corded Current Control

Flush Socket Tools



Flush Socket Series

Torque Range
4.9 - 234 Nm
3.6 - 172.6 Ft. Lbs.

Bolt Size
M8 - M21
1/2" - 1 3/16"

- Brushless precision
- Resolver control
- Memory intelligence

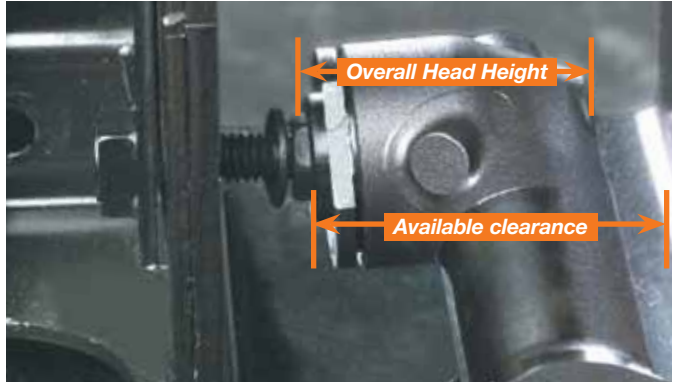

Flush socket tools have plenty of clearance to fit low clearance applications. Electric flush socket tools tighten with much higher accuracy than tools with crowfoot attachment.



Flush Socket Tool Nomenclature

XX	C	A	E	XXX	FX
Motor 18, 48	Current Control	Connector E – Air-LB			
Tool Style A – Right Angle					
Max Output Torque					
F1 16,23, 30 Nm		F3 53, 75, 110 Nm			
F2 37, 52 Nm		F4 135, 230 Nm			
<60 Nm, rounded up to the nearest 1 Nm. >60 Nm, rounded to the nearest 5 Nm.					
Head Type					
F1 Head 8–15mm socket capacity		F2 Head 10–15mm socket capacity			
F3 Head 13–21mm socket capacity		F4 Head 13–21mm socket capacity			

Socket Nomenclature

FX	XX	X	X
Flush Socket	Output Type		
1 F1	0–Standard 1–Fast Lead 2–Magnetic		
2 F2			
3 F3	Extension Length		
4 F4	0 – Flush 4 – 1/2" 8 – 1"		
	2 – 1/4" 6 – 3/4"		
Socket Size			
EC – 3/8	MB – 8mm (5/16")	MJ – 16mm (5/8")	
ED – 7/16	MD – 10mm	MK – 17mm	
EE – 1/2	ME – 11mm (7/16")	ML – 18mm	
EF – 9/16	MF – 12mm	MM – 19mm (3/4")	
EH – 11/16	MG – 13mm	MN – 20mm	
EJ – 13/16	MH – 14mm	MO – 21mm	
	MI – 15mm		

X Dimension For Flush Socket

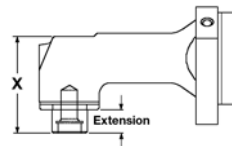

Head	in.	mm	Socket Size Range
F1	1.54	39	8–15mm
F2	1.69	43	10–15mm
F3	2.32	59	13–21mm
F4	2.4	61	17–21mm

Note: To order a tool include the Socket Nomenclature with the Tool Nomenclature. Order just the Socket Nomenclature for a complete head assembly. Refer to Parts List for individual socket part numbers.

Flush Socket	Head Type	Torque Range		Free Speed	Weight*		Length		Anglehead			
		ft. lbs.	Nm		RPM	lbs.	kg	in.	mm	Side to Center		Height
Model Number									in.	mm	in.	mm
18CAE16F1	F1	3.6-11.8	4.9-16	1225	4.4	2.00	16.0	406	0.55	14	1.54	39
18CAE23F1	F1	3.4-17.0	4.6-23	860	4.4	2.00	16.0	406	0.55	14	1.54	39
18CAE30F1	F1	4.4-22.1	6.0-30	655	4.4	2.00	16.0	406	0.55	14	1.54	39
48CAE37F2	F2	5.9-27.3	8.0-37	1225	5.4	2.43	18.7	474	0.67	17	1.69	43
48CAE52F2	F2	8.1-38.3	11-52	860	5.4	2.43	18.7	474	0.67	17	1.69	43
48CAE53F3	F3	8.1-39.0	11-53	850	6.0	2.74	20.0	509	0.87	22	2.32	59
48CAE75F3	F3	11.1-55.3	15-75	600	6.0	2.74	20.0	509	0.87	22	2.32	59
48CAE110F3	F3	17.0-81.1	23-110	400	7.4	3.38	20.5	521	0.87	22	2.32	59
48CAE135F4	F4	19.9-99.5	27-135	270	8.9	4.03	20.6	522	1.06	27	2.40	61
48CAE230F4	F4	34.7-172.6	47-230	150	10.6	4.79	22.2	563	1.06	27	2.40	61

*Weights are without tool cable or reaction bar if so equipped.

General: All tools must be used with an approved ATG cable and controller.

Standard Equipment: Air-LB Connector.

Extra Equipment: Std. tool cable 301866-XX, RA swivel cable 301903-XX, Inline swivel cable 301904-XX, Extension cable 301877-XX.

Additional Accessories: See pages 121-129 for additional accessories.

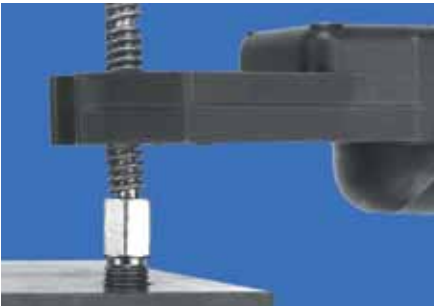
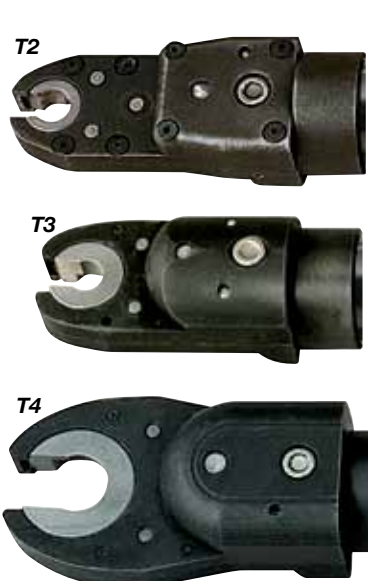

The 48ET tube nut wrench alternates the direction of rotation each time the lever is actuated. When rotating in reverse, the socket will stop at the open position.

Cleco®

Tube Nut Series

Torque Range	Bolt Size
10 - 40 Nm	M6 - M10
7.4 - 29.5 Ft. Lbs.	1/4" - 3/8"

- Brushless precision
- Resolver control
- Memory intelligence

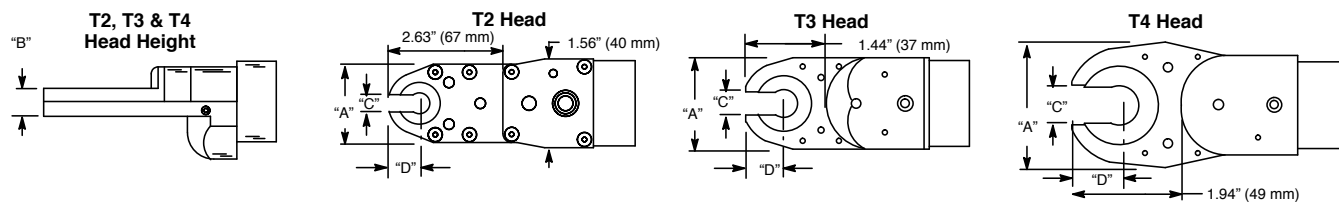

Tube Nut Tool Nomenclature

XX	C	T	E	XX	XX
Motor 48	Current Control	Connector E - Air-LB			

Tool Style
T - Tube Nut

Max Output Torque
<60 Nm, rounded up to the nearest 1 Nm.

Head Type
T2 - 20 Nm
T3 - 30 Nm
T4 - 40 Nm

Socket Nomenclature

KSX	XX	XX	X
Head Type KS2 - T2 KS3 - T3 KS4 - T4			Output Type 0 - Partial Thru Hex 2 - Double Thru Hex 1 - Thru Hex 3 - Partial Thru Double Hex

Extension Length
0 - Flush 4 - 1/2" 8 - 1"
2 - 1/4" 6 - 3/4"

Maximum Hex Socket Size
MG, EE T2 Head Type
MM, 3/4" T3 Head Type
MU, 1 1/16" T4 Head Type
00, ## (Specials) All Head Types

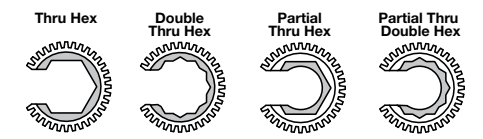

EA - 1/4"	M5 - 5mm	MH - 14mm	MP - 22mm
EC - 3/8"	M6 - 6mm	MI - 15mm	MQ - 23mm
EE - 1/2"	MA - 7mm	MJ - 16mm (5/8)	MR - 24mm (15/16)
EF - 9/16"	MB - 8mm (5/16)	MK - 17mm	MS - 25mm
EH - 11/16"	MD - 10mm	ML - 18mm	MT - 26mm
EJ - 13/16"	ME - 11mm (7/16)	MM - 19mm (3/4)	MU - 27mm (1 1/16)
EK - 7/8"	MF - 12mm	MN - 20mm	
EM - 1"	MG - 13mm	MO - 21mm	

Note: To order a tool include the Socket Nomenclature with the Tool Nomenclature.
Order T2XXXX for a complete head assembly (i.e. T2MF02)
To order individual sockets, use a "KS" prefix (i.e. KS2EA01 for a T2 1/4", Flush, Thru Hex socket.)

Tube Nut	Max. Drive Size	Torque Range		Free Speed	Weight*	Length		Head								
		Ft.Lbs.	Nm			RPM	lbs.	kg	A Width		B Blade Ht.		C Opening		D End/Cntr.	
									in.	mm	in.	mm	in.	mm	in.	mm
48CTE20T2	1/2"	7.4-14.8	10-20	1425	4.4	2.0	16.9	430	1.42	36	0.55	14	0.28	7	0.53	13
48CTE30T3	3/4"	11.1-22.1	15-30	1030	4.5	2.0	16.6	422	1.65	42	0.59	15	0.475	13	0.73	19
48CTE40T4	1 1/16"	14.8-29.5	20-40	770	5.3	2.3	17.9	454	2.36	60	0.59	15	0.675	18	0.93	24

*Weights are without tool cable and reaction bar.
General: All tools must be used with an approved ATG cable and controller.
Standard Equipment: Air-LB Connector.

Extra Equipment: Std. tool cable 301866-XX, RA swivel cable 301903-XX, Inline swivel cable 301904-XX, Extension cable 301877-XX.
Additional Accessories: See pages 121-129 for additional accessories.

Electric Nutrunners – Corded Current Control

Right Angle Floating Spindle Tools

Cleco®

Right Angle Floating Spindle Series

Torque Range
5.1 - 230 Nm
3.7 - 169.6 Ft. Lbs.

Bolt Size
M7 - M18
1/4" - 3/4"

- Brushless precision
- Resolver control
- Memory intelligence



48CAE135S461

Right Angle Floating Spindle Tool Nomenclature

XX	C	A	E	XXX	XX	X	X
Motor 18 48	Current Control	Connector E – Air-LB			Square Drive 3 - 3/8" (S1,S2) 4 - 1/2" (S3,S4) 6 - 3/4" (S4)	Extension Length	
Tool Style A – Right Angle					1 -1.13" (S1), 1.00" (S2 & S3), 1.25" (S4) 2 -2.13" (S1), 3.00" (S2), 2.5" (S4 1/2" Dr.) 5 -5.13" (S2), 4.25" (S4) 6 -6.0" (S4 1/2" Dr.), 7.0" (S4 3/4" Dr.) 11 -11.0" (S4 3/4" Dr.)		
Max Output Torque				Tool Termination			
S1 Head – 16, 23, or 30 Nm				S1 Sliding (Floating) Spindle			
S2 Head – 37 or 52 Nm				S2 Sliding (Floating) Spindle			
S3 Head – 53, 75, 95, or 110 Nm				S3 Sliding (Floating) Spindle			
S4 Head – 135 or 230 Nm (48 series)				S4 Sliding (Floating) Spindle			

Right Angle Floating Spindle Model Number	Torque Range		Max. Speed RPM	Weight*		Output Drive Size	Length		Side to Center	
	ft. lbs.	Nm		lbs.	kg		in.	mm	in.	mm
18CAE16S131	3.7-11.8	5.1-16	1225	4.4	2.00	3/8"	16.0	406	0.55	14
18CAE23S131	5.3-16.9	7.2-23	860	4.4	2.00	3/8"	16.0	406	0.55	14
18CAE30S131	4.4-22.1	6.0-30	655	4.4	2.00	3/8"	16.0	406	0.55	14
48CAE37S231	5.9-27.2	8.0-37	1225	5.4	2.43	3/8"	18.7	474	0.67	17
48CAE52S231	8.1-38.3	11-52	860	5.4	2.43	3/8"	18.7	474	0.67	17
48CAE53S341	8.1-39.1	11-53	850	6.0	2.74	1/2"	20.0	509	0.87	22
48CAE75S341	11.0-55.3	15-75	600	6.0	2.74	1/2"	20.0	509	0.87	22
48CAE95S341	14.7-70.0	20-95	460	7.4	3.38	1/2"	20.5	521	0.87	22
48CAE110S341	16.9-81.1	23-110	400	7.4	3.38	1/2"	20.5	521	0.87	22
48CAE135S461	20.6-99.5	28-135	270	8.9	4.03	3/4"	20.6	522	1.06	27
48CAE230S461	34.6-169.6	47-230	150	10.6	4.79	3/4"	22.2	563	1.06	27

*Weights are without tool cable and mounting plate.

General: All tools must be used with an approved ATG cable and controller.

Standard Equipment: Air-LB Connector; Mounting plate.

Extra Equipment: Std. tool cable 301866-XX, RA swivel cable 301903-XX, Inline swivel cable 301904-XX, Extension cable 301877-XX.

Additional Accessories: See pages 121-129 for additional accessories.

18CAE & 48CAE Floating Spindle Angle Heads

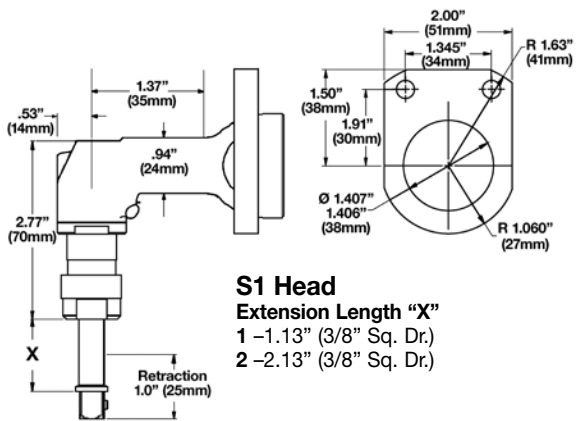

S1 Head
 Extension Length "X"
 1 -1.13" (3/8" Sq. Dr.)
 2 -2.13" (3/8" Sq. Dr.)

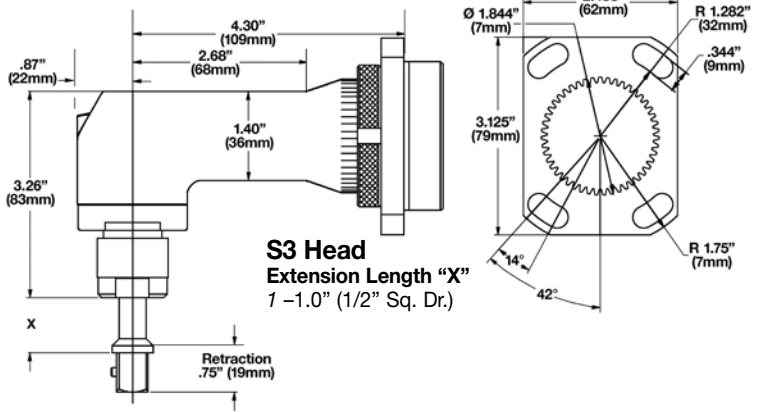

S3 Head
 Extension Length "X"
 1 -1.0" (1/2" Sq. Dr.)

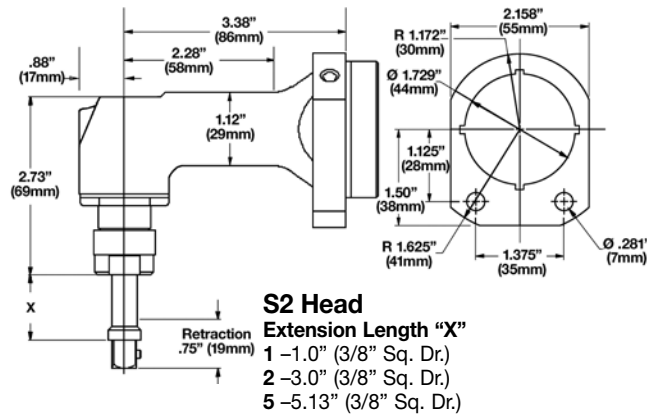

S2 Head
 Extension Length "X"
 1 -1.0" (3/8" Sq. Dr.)
 2 -3.0" (3/8" Sq. Dr.)
 5 -5.13" (3/8" Sq. Dr.)

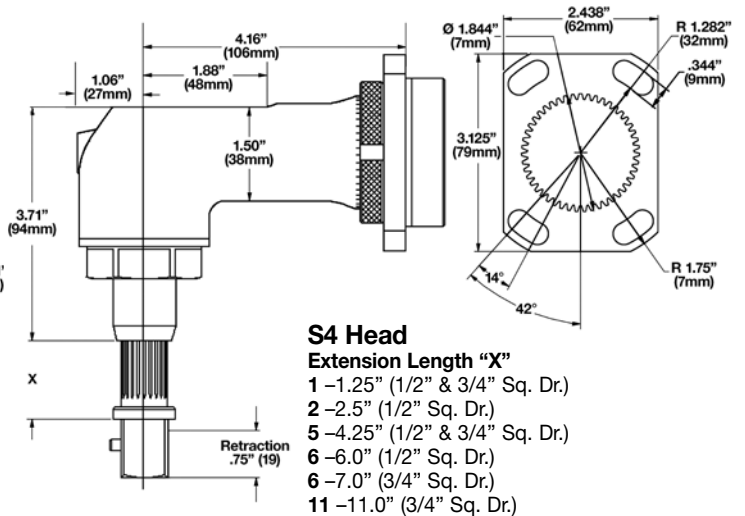

S4 Head
 Extension Length "X"
 1 -1.25" (1/2" & 3/4" Sq. Dr.)
 2 -2.5" (1/2" Sq. Dr.)
 5 -4.25" (1/2" & 3/4" Sq. Dr.)
 6 -6.0" (1/2" Sq. Dr.)
 6 -7.0" (3/4" Sq. Dr.)
 11 -11.0" (3/4" Sq. Dr.)



Electric Nutrunners – Corded Current Control

Crowfoot Tools

Cleco®

Crowfoot Series

Torque Range
7 - 30 Nm
5 - 22 Ft. Lbs.

Bolt Size
M6 - M8
#10 - 3/8"

- Brushless precision
- Resolver control
- Memory intelligence



48CCE30C1

Crowfoot Tool Nomenclature

48	C	C	E	XX	XX
Motor 48	Current Control	Connector E – Air-LB			
Tool Style C – Crowfoot					
Max Output Torque					
Head Type					
C1 - 15° Crowfoot					
C3 - 30° Crowfoot					

Socket Nomenclature

CS	XX	XX	X
Socket Type CS – Crowfoot	Output Style 1 – Thru Hex		
Extension Length			
0 – Flush			
4 – 1/2"			
6 – 3/4"			
Socket Size			
EA – 1/4"	MC – 9mm		
EC – 3/8	MD – 10mm		
EE – 1/2	ME – 11mm (7/16)		
EF – 9/16	MF – 12mm		
MA – 7mm	MG – 13mm		
MB – 8mm (5/16)	MH – 14mm		
	MI – 15mm*		
*Fragile. Light duty apps.			

Note: To order a tool include the Socket Nomenclature with the Tool Nomenclature.
To order individual sockets, use "CS" prefix before the required socket. (i.e. CSEA01 for a 1/4", flush, thru hex socket.)

Crowfoot		Torque Range		Free Speed	Weight*		Length	
Model Number		ft. lbs.	Nm	RPM	lbs.	kg	in.	mm
15° Head	30° Head							
48CCE30C1	48CCE30C3	7.7-22.1	10.5-30	860	5.5	2.3	20.5	521

*Weights are without tool cable and reaction bar.

General: All tools must be used with an approved ATG cable and controller.

Standard Equipment: Air-LB Connector.

Extra Equipment: Std. tool cable 301866-XX, RA swivel cable 301903-XX, Inline swivel cable 301904-XX, Extension cable 301877-XX.

Additional Accessories: See pages 121-129 for additional accessories.

To order individual sockets, use a "CS" prefix before the required socket. (i.e. CSEA01 for a, 1/4", flush, thru hex socket.)

C1 – 15° Head (Part No. 301959)

Maximum Recommended Torque: 22 ft.lbs. (30 Nm)

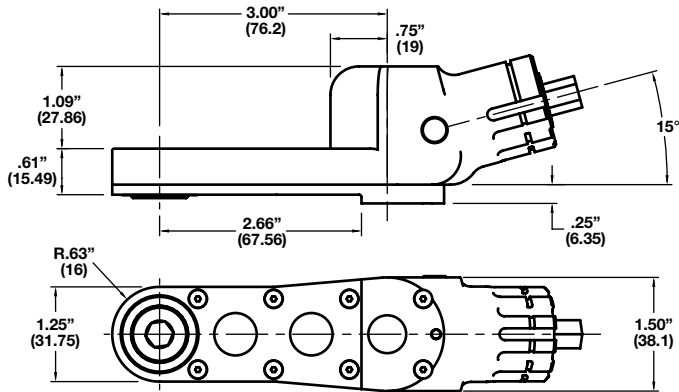

C3 – 30° Head (Part No. 301960)

Maximum Recommended Torque: 22 ft.lbs. (30 Nm)

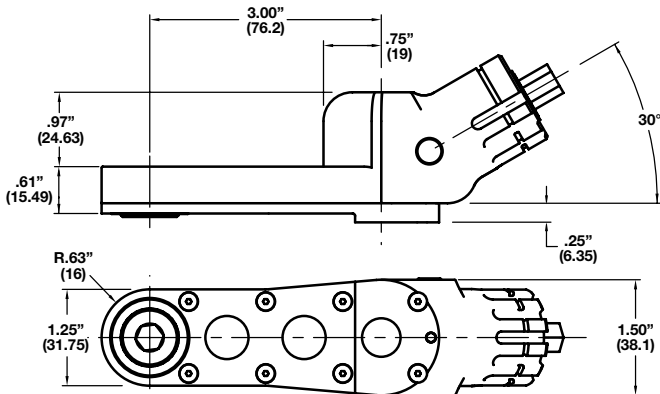

How To Build A Fixtured DC Tool System

Building a Fixtured DC Tool System is as simple as 1, 2, 3!

1. Choose a common system to the right.
2. Select the correct components below.
3. Order your System!



System Control Package - Intelligent Spindle (Page 89)

Controller, Power Transformer, Power Distribution Box, Arcnet Cable, and Stand



Intelligent Fixtured Spindle (Page 64-87)



Floating Spindle Adapters (Page 122)



Field Cables - Intelligent Spindle (Page 88)



Jumper/Extension Cables - Intelligent Spindle (Page 88)



System Bus Terminator at spindle - Intelligent Spindle (Page 88)



Controller - Conventional Spindle (Page 114-118)



Conventional Fixtured Spindle (Pages 90-111)



Floating Spindle Adapters (Page 113)



Field Cables - Conventional Spindle (Page 122)



Extension Cables - Conventional Spindle (Page 122)



System Bus Cable - (Page 124)



Add or delete components as required.

Model/Part Number	>2 Convent. Spindles - Consult Application Center	>2 Intelligent Spindles - Consult Application Center	Single Application Center	Two Intelligent Spindle	Conventional 1-2 Spindle (Size 1, 2)	Conventional 1-2 Spindle (Size 3, 4)	Conventional >2 Spindle (Size 1, 2)	Conventional >2 Spindle (Size 3, 4)			
mPro400GCM PDBCPSXX - Select model from catalog.									1	1	
Select from catalog. Floating spindle ordered separately.									1	2	
Select from catalog.									1	2	
Select cable with desired connector from catalog.									1	1	
Select cable with desired connector from catalog.									1	1	
961127									1	1	
mPro400GC-SG-12 Compact Box	1		1								
mPro400GC-SG-34 Compact Box		1		1							
Select from catalog. Floating spindle ordered separately.	1	1	*	*							
Select from catalog.	1	1	*	*							
Select from catalog.	1	1	*	*							
Select from catalog.	1	1	*	*							
Select from catalog. <i>** (Included in the System Control Package)</i>		1		1					**	**	

*As required.

There's A DGD Intelligent S

With straight drive, offset drive, and angle drive configurations, each available with reversible gears, and four different motor sizes to suit different torque requirements, there's a DGD Intelligent Spindle to fit most any situation. Your Apex Tool Group Technical

Sales Representative will work with you to determine the best solution for you. We can also provide you with application assistance in automation integration, joint analysis testing, complex data connection, and more.

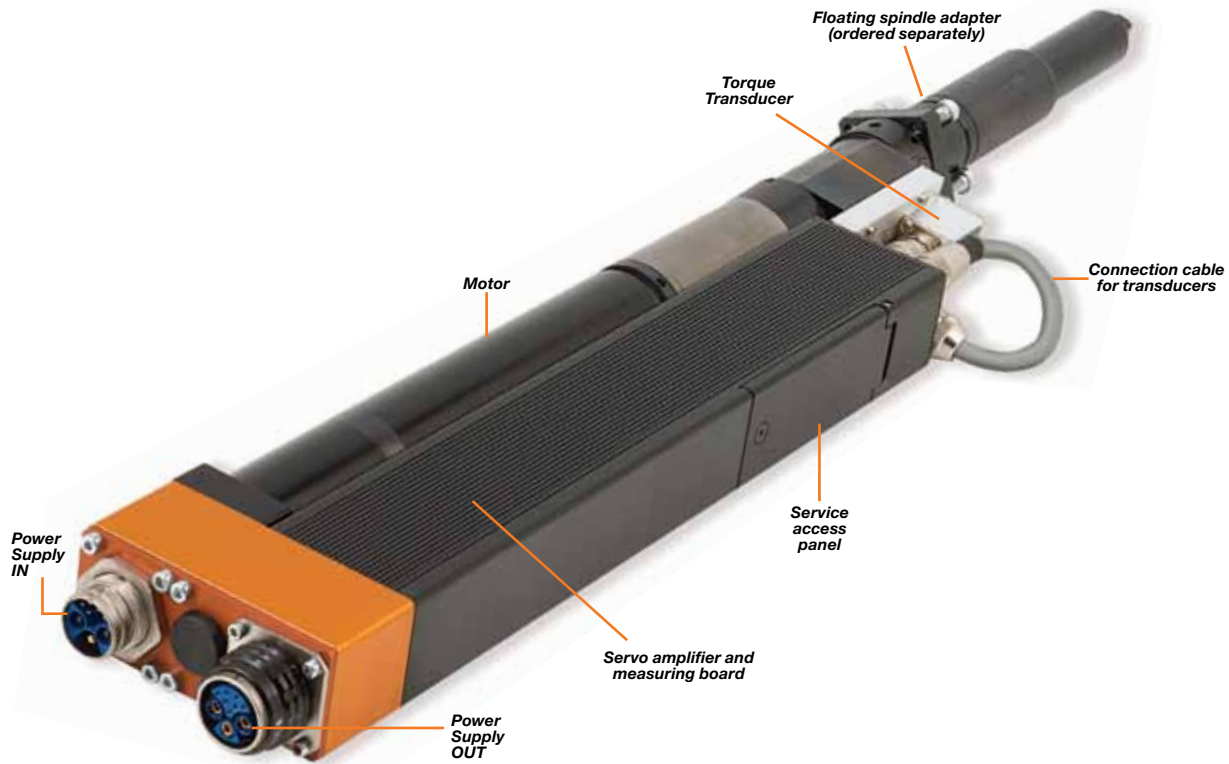

Example **1** **BTSE** **1B035A** **2/** **1M1B** **1ZB**

X **XXXX** **XXXXXX** **X** **XXXX** **XXXXX**

Size
1, 2, 3, 4

Motor with servoamplifier & measurement card
B - Brushless Motor
U - Reverse gearing
TS - Tightening System
E - Standard

Gear
1 - Size
B - Brushless motor gear
XXX - Max. torque
A - Generation

2nd Transducer for cross check
2 - 2x only for Z attachment

Attachment
1 - Size
Z - Straight attachment
VK - Offset drive with transducer
WK - Angle drive with transducer
1 - Capacity level
B - Version

Transducer
1 - Size
K - Combination torque + angle
1 - Capacity level 1 or 2
B - Version
M - Only moment, no angle encoder

Note: Floating spindle adapter must be ordered separately.

Intelligent Spindle Sizes and Torque Ranges

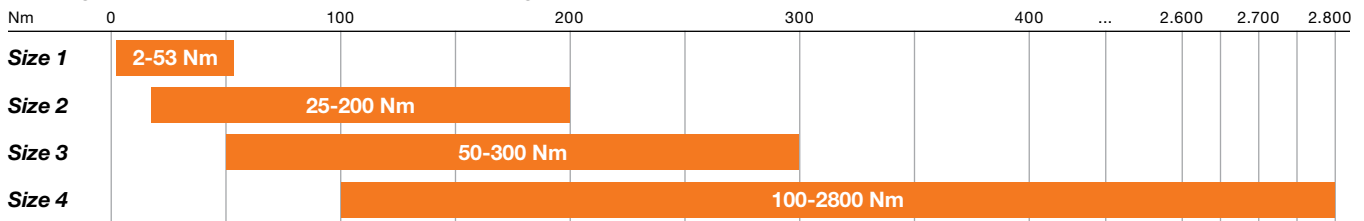

Spindle For Your Application

Intelligent Spindle Configurations

Straight Drive



Straight Drive with reversible gears



Offset Drive



Offset Drive with reversible gears











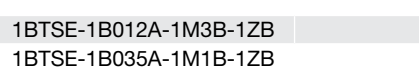

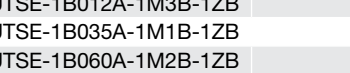
Angle Drive

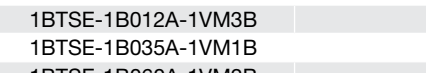

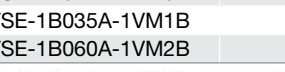
Angle Drive with reversible gears

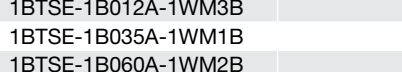

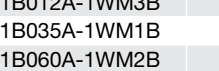
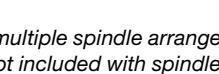
	Min. Center-Center	L	Weight	Design	Order No. DGD Spindle	Floating Adapter		Floating Adapter incl. guide housing
	mm	mm	kg			Order No.	X (mm)	Order No.
	43	486	4.8	1BTSE-1B012A-1M3B-1ZB		922325PT	180	S308434
	43	486	4.8	1BTSE-1B035A-1M1B-1ZB		922325PT	180	S308434
	43	486	4.8	1BTSE-1B060A-1M2B-1ZB		922325PT	180	S308434
	43	393	5.3	1BUTSE-1B012A-1M3B-1ZB		922325PT	180	S308434
	43	393	5.3	1BUTSE-1B035A-1M1B-1ZB		922325PT	180	S308434
	43	393	5.3	1BUTSE-1B060A-1M2B-1ZB		922325PT	180	S308434
	35	474	5.3	1BTSE-1B012A-1VM3B		922325PT	180	S308437
	35	474	5.3	1BTSE-1B035A-1VM1B		922325PT	180	S308437
	35	474	5.3	1BTSE-1B060A-1VM2B		922325PT	180	S308437
	35	382	5.8	1BUTSE-1B012A-1VM3B		922325PT	180	S308437
	35	382	5.8	1BUTSE-1B035A-1VM1B		922325PT	180	S308437
	35	382	5.8	1BUTSE-1B060A-1VM2B		922325PT	180	S308437
	52	542	5.7	1BTSE-1B012A-1WM3B				929041
	52	542	5.7	1BTSE-1B035A-1WM1B				929041
	52	542	5.7	1BTSE-1B060A-1WM2B				929041
	52	370	6.2	1BUTSE-1B012A-1WM3B				929041
	52	370	6.2	1BUTSE-1B035A-1WM1B				929041
	52	370	6.2	1BUTSE-1B060A-1WM2B				929041

For angle attachment

For angle attachment

The transducer can be rotated for crowded multiple spindle arrangements (DGD 15° radial toothing). = maximum accessibility. Floating adapter not included with spindle.

2D and 3D are available to download at www.apexpowertools.com in the Customer Support section or on www.apexpowertools.eu in the download area.

BTSE Models	Torque Range	Speed	Float	Square Drive
	Nm	RPM	mm	inch

Straight drive, single transducer

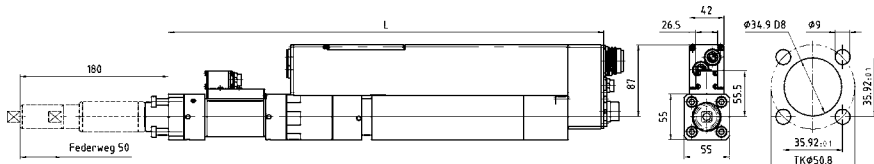
	25-110	890	50	1/2"
	40-200	502	50	3/4"

Straight drive with reversible gears, single transducer

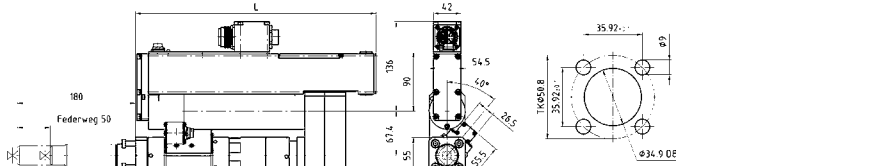
	25-110	890	50	1/2"
	40-200	502	50	3/4"

Offset drive, single transducer

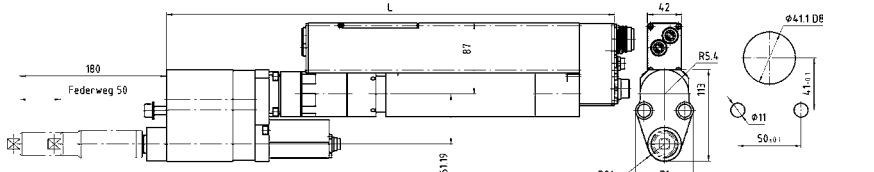
	25-110	831	50	1/2"
	40-200	468	50	3/4"

Offset drive with reversible gears, single transducer

	25-110	831	50	1/2"
	40-200	468	50	3/4"



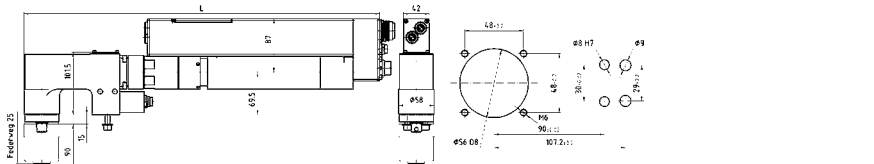













Angle drive, single transducer

	25-110	838	25	1/2"
	40-200	472	25	3/4"

Angle drive with reversible gears, single transducer

	25-110	838	25	1/2"
	40-200	472	25	3/4"

Smallest scribed circle diameter in mm			
Number of spindles	Model 2		
	Straight	Offset	Angle drive
2	56	44	59
3	75	50	68
4	80	62	86
5	106	74	101
6	130	89	118
7	151	102	137

	Min. Center-Center	L	Weight	Design	Order No. DGD Spindle	Floating Adapter		Floating Adapter incl. guide housing
	mm	mm	kg			Order No.	X (mm)	Order No.
								
	56	528	7.6	2BTSE-2B110A-2M1B-2ZB		910609	180	S308435
	56	528	7.6	2BTSE-2B200A-2M3B-2ZB		935552	180	S308450
								
	56	367	8.6	2BUTSE-2B110A-2M1B-2ZB		910609	180	S308435
	56	367	8.6	2BUTSE-2B200A-2M3B-2ZB		935552	180	S308450
								
	44	551	9.2	2BTSE-2B110A-2VM1B		910609	180	S308438
	44	551	9.2	2BTSE-2B200A-2VM3B		935552	180	S308475
								
	44	390	10.2	2BUTSE-2B110A-2VM1B		910609	180	S308438
	44	390	10.2	2BUTSE-2B200A-2VM3B		935552	180	S308475
								
	59	581	8.7	2BTSE-2B110A-2WM1B				929053
	59	581	8.7	2BTSE-2B200A-2WM3B				929061
								
	59	421	9.7	2BUTSE-2B110A-2WM1B				929053
	59	421	9.7	2BUTSE-2B200A-2WM3B				929061

The transducer can be rotated for crowded multiple spindle arrangements (DGD 15° radial toothing).
= maximum accessibility. Floating adapter not included with spindle.

2D and 3D are available to download at www.apexpowertools.com in the Customer Support section or on www.apexpowertools.eu in the download area.

BTSE Models	Torque Range	Speed	Float	Square Drive
	Nm	RPM max.	mm	inch

Straight drive, single transducer

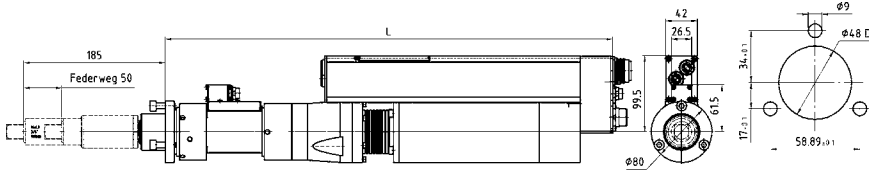

50-300	453	50	3/4"
--------	-----	----	------

Straight drive with reversible gears, single transducer

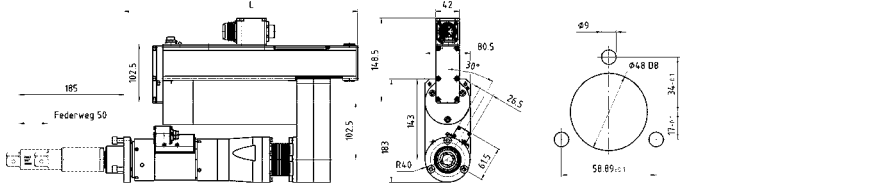

50-300	453	50	3/4"
--------	-----	----	------

Offset drive, single transducer

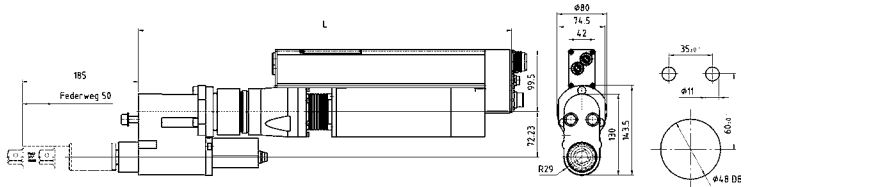

50-300	421	50	3/4"
--------	-----	----	------

Offset drive with reversible gears, single transducer

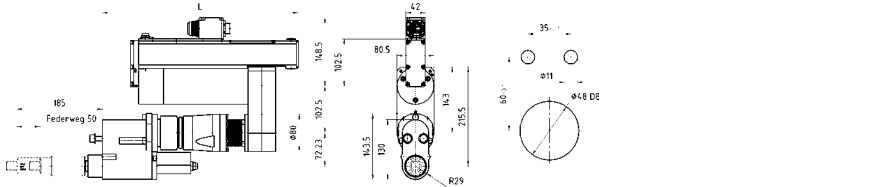

50-300	421	50	3/4"
--------	-----	----	------

Angle drive, single transducer

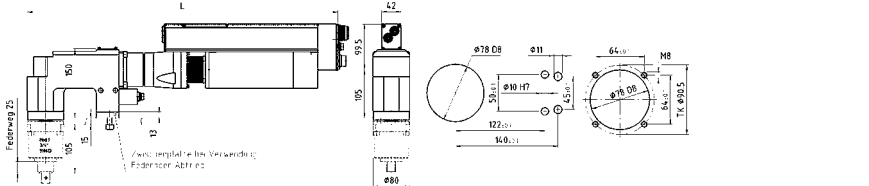

50-300	437	25	3/4"
--------	-----	----	------

Angle drive with reversible gears, single transducer

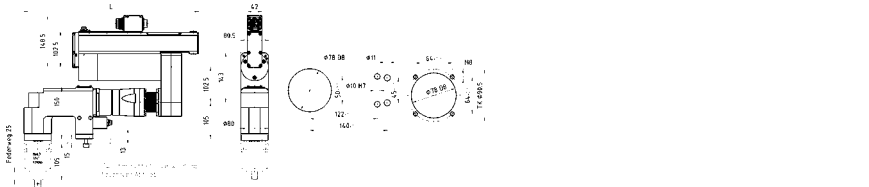

50-300	437	25	3/4"
--------	-----	----	------

Smallest scribed circle diameter in mm

Number of spindles	Model 3		
	Attachment		Angle drive
	Straight	Offset	
2	81	59	81
3	94	69	94
4	116	84	116
5	139	102	139
6	164	122	164
7	189	138	189

	Min. Center-Center	L	Weight	Design	Order No. DGD Spindle	Floating Adapter		Floating Adapter incl. guide housing
	mm	mm	kg			Order No.	X (mm)	Order No.
	81	589	14.1	3BTSE-3B300A-3M2B-3ZB	910613	185	S308436	
	81	417	16.1	3BUTSE-3B300A-3M2B-3ZB	910613	185	S308436	
	59	584	15.2	3BTSE-3B300A-3VM2B	910613	185	S308439	
	59	412	17.2	3BUTSE-3B300A-3VM2B	910613	185	S308439	
	81	678	17.8	3BTSE-3B300A-3WM2B			929065 <i>For angle attachment</i>	
	81	506	19.8	3BUTSE-3B300A-3WM2B			929065 <i>For angle attachment</i>	

The transducer can be rotated for crowded multiple spindle arrangements (DGD 15° radial toothing).
 = maximum accessibility. Floating adapter not included with spindle.
 2D and 3D are available to download at www.apexpowertools.com in the Customer Support section or on www.apexpowertools.eu in the download area.

BTSE Models	Torque Range	Speed	Float	Square Drive
		RPM		
	Nm	max.	mm	inch

Straight drive, single transducer

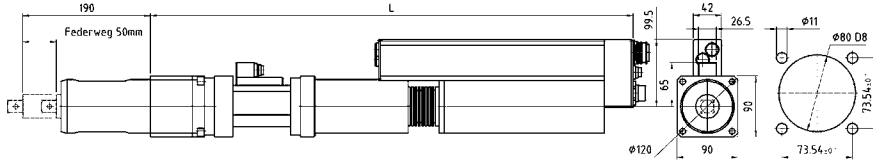

100-500	254	50	3/4"
130-660	174	50	1"
320-1250 ¹	86	50	1"
400-1600 ¹	68	50	1 1/2"
980-2800	37	--	1 1/2"

Straight drive with reversible gears, single transducer

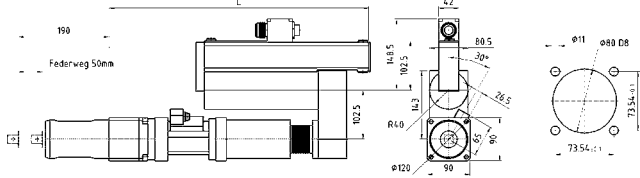

100-500	254	50	3/4"
130-660	174	50	1"
320-1250 ¹	86	50	1"
400-1600 ¹	68	50	1 1/2"

Offset drive, single transducer

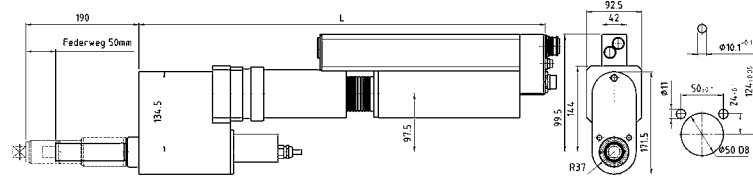

100-500	238	50	3/4"
130-660	163	50	1"
160-750	135	50	1"

Offset drive with reversible gears, single transducer

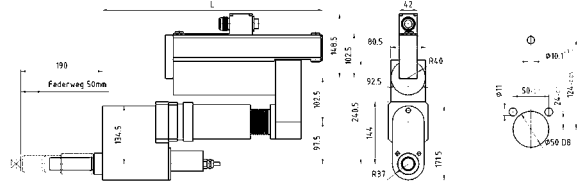

100-500	238	50	3/4"
130-660	163	50	1"
160-750	135	50	1"

Angle drive, single transducer

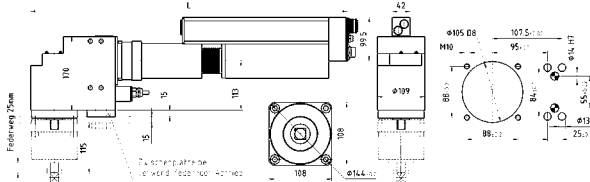

100-500	245	25	1"
130-660	167	25	1"

Angle drive with reversible gears, single transducer

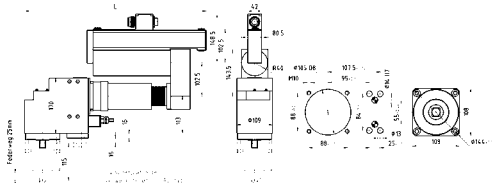















100-500	245	25	1"
130-660	167	25	1"

¹ Special version - technical drawings on request.

*2800 Nm spindle available on request.

Number of spindles	Smallest scribed circle diameter in mm			
	Model 4			
	Straight	Attachment *	Offset	Angle drive
2	91	121	76	112
3	122	152	88	130
4	130	172	108	160
5	174	230	130	192
6	217	281	153	224
7	246	327	180	263

	Min. Center-Center	L	Weight	Design	Order No. DGD Spindle	Floating Adapter		Floating Adapter incl. guide housing
	mm	mm	kg			Order No.	X (mm)	Order No.
								
	91	719	21	4BTSE-4B500A-4M2B-4ZA		916643	190	
	91	719	21	4BTSE-4B660A-4M3B-4ZA		916642	186	
	121*	771	29	4BTSE-4B360A-4M1B-4Z1250A		S976956	140	
	121*	771	29	4BTSE-4B500A-4M2B-4Z1600A		S308441	140	
	160*	790	39.73	4BTSE-4B660A-4M3B-4Z2800G				
								
	91	546	22.5	4BUTSE-4B500A-4M2B-4ZA		916643	190	
	91	546	22.5	4BUTSE-4B660A-4M3B-4ZA		916642	186	
	121*	599	31	4BUTSE-4B360A-4M1B-4Z1250A		S976956	140	
	121*	599	31	4BUTSE-4B500A-4M2B-4Z1600A		S308441	140	
								
	76	684	22.5	4BTSE-4B500A-4VM2B		912106	190	S308440
	76	684	22.5	4BTSE-4B660A-4VM3B		912147	186	S308474
	76	684	23	4BTSE-4B660A-4VM4B		912147	186	S308474
								
	76	512	24	4BUTSE-4B500A-4VM2B		912106	190	S308440
	76	512	24	4BUTSE-4B660A-4VM3B		912147	186	S308474
	76	512	24.5	4BUTSE-4B660A-4VM4B		912147	186	S308474
								
	112	729	27.1	4BTSE-4B500A-4WM2B				929089
	112	729	27.1	4BTSE-4B660A-4WM3B				929089
								
	112	556	28.6	4BUTSE-4B500A-4WM2B				929089
	112	556	28.7	4BUTSE-4B660A-4WM3B				929089

[†] Special version - technical drawings on request

The transducer can be rotated for crowded multiple spindle arrangements (DGD 15° radial toothing).

= maximum accessibility. Floating adapter not included with spindle.

2D and 3D are available to download at www.apexpowertools.com in the Customer Support section or on www.apexpowertools.eu in the download area.

BTS Models	Torque Range	Speed	Float	Square Drive
		RPM		
	Nm	max.	mm	inch
Straight drive, single transducer	2-12	1921	50	3/8"
	5-35	727	50	3/8"
	15-53	427	50	3/8"

Straight drive with reversible gears, single transducer	2-12	1921	50	3/8"
	5-35	727	50	3/8"
	15-53	427	50	3/8"











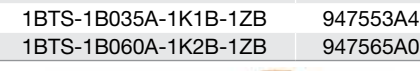

Offset drive, single transducer	2-12	1825	50	3/8"
	5-35	690	50	3/8"
	15-53	405	50	3/8"

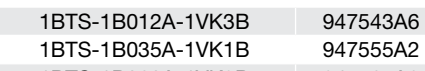
Offset drive with reversible gears, single transducer	2-12	1825	50	3/8"
	5-35	690	50	3/8"
	15-53	405	50	3/8"

Angle drive, single transducer	2-12	1801	25	3/8"
	5-35	681	25	3/8"
	15-53	400	25	3/8"

Angle drive with reversible gears, single transducer	2-12	1801	25	3/8"
	5-35	681	25	3/8"
	15-53	400	25	3/8"

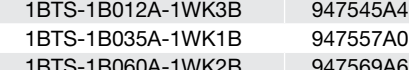
Smallest scribed circle diameter in mm				
Number of spindles	Model 1			
	Attachment			Angle drive
	Straight		Offset	
2	43		35	52
3	54		40	60
4	61		50	74
5	81		58	89
6	99		70	105
7	116		85	120

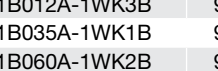
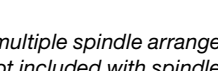















	Min. Center-Center	L	Weight	Design	Order No. DGD Spindle	Floating Adapter		Floating Adapter incl. guide housing
	mm	mm	kg			Order No.	X (mm)	Order No.
	43	486	4.8	1BTS-1B012A-1K3B-1ZB	947541A8	922325PT	180	S308434
	43	486	4.8	1BTS-1B035A-1K1B-1ZB	947553A4	922325PT	180	S308434
	43	486	4.8	1BTS-1B060A-1K2B-1ZB	947565A0	922325PT	180	S308434
	43	393	5.3	1BUTS-1B012A-1K3B-1ZB	947547A2	922325PT	180	S308434
	43	393	5.3	1BUTS-1B035A-1K1B-1ZB	947559A8	922325PT	180	S308434
	43	393	5.3	1BUTS-1B060A-1K2B-1ZB	947571A2	922325PT	180	S308434
	35	474	5.3	1BTS-1B012A-1VK3B	947543A6	922325PT	180	S308437
	35	474	5.3	1BTS-1B035A-1VK1B	947555A2	922325PT	180	S308437
	35	474	5.3	1BTS-1B060A-1VK2B	947567A8	922325PT	180	S308437
	35	382	5.8	1BUTS-1B012A-1VK3B	947549A0	922325PT	180	S308437
	35	382	5.8	1BUTS-1B035A-1VK1B	947561A4	922325PT	180	S308437
	35	382	5.8	1BUTS-1B060A-1VK2B	947573A0	922325PT	180	S308437
	52	542	5.7	1BTS-1B012A-1WK3B	947545A4			929041
	52	542	5.7	1BTS-1B035A-1WK1B	947557A0			929041
	52	542	5.7	1BTS-1B060A-1WK2B	947569A6			929041
	52	370	6.2	1BUTS-1B012A-1WK3B	947551A6			929041
	52	370	6.2	1BUTS-1B035A-1WK1B	947563A2			929041
	52	370	6.2	1BUTS-1B060A-1WK2B	947575A8			929041

For angle attachment

For angle attachment

The transducer can be rotated for crowded multiple spindle arrangements (DGD 15° radial toothing). = maximum accessibility. Floating adapter not included with spindle.

2D and 3D are available to download at www.apexpowertools.com in the Customer Support section or on www.apexpowertools.eu in the download area.

	Min. Center-Center	L	Weight	Design	Order No. DGD Spindle	Floating Adapter		Floating Adapter incl. guide housing
	mm	mm	kg			Order No.	X (mm)	Order No.
								
	43	566	5.4	1BTS-1B012A-2/1K3B-1ZB	947542A7	922325PT	180	S308434
	43	566	5.4	1BTS-1B035A-2/1K1B-1ZB	947554A3	922325PT	180	S308434
	43	566	5.4	1BTS-1B060A-2/1K2B-1ZB	947566A9	922325PT	180	S308434
								
	43	393	5.9	1BUTS-1B012A-2/1K3B-1ZB	947548A1	922325PT	180	S308434
	43	393	5.9	1BUTS-1B035A-2/1K1B-1ZB	947560A5	922325PT	180	S308434
	43	393	5.9	1BUTS-1B060A-2/1K2B-1ZB	947572A1	922325PT	180	S308434
								
	35	554	5.9	1BTS-1B012A-1K3B-1VK3B	947544A5	922325PT	180	S308437
	35	554	5.9	1BTS-1B035A-1K1B-1VK1B	947556A1	922325PT	180	S308437
	35	554	5.9	1BTS-1B060A-1K2B-1VK2B	947568A7	922325PT	180	S308437
								
	35	382	6.4	1BUTS-1B012A-1K3B-1VK3B	947550A7	922325PT	180	S308437
	35	382	6.4	1BUTS-1B035A-1K1B-1VK1B	947562A3	922325PT	180	S308437
	35	382	6.4	1BUTS-1B060A-1K2B-1VK2B	947574A9	922325PT	180	S308437
								
	52	622	6.3	1BTS-1B012A-1K3B-1WK3B	947546A3			929041
	52	622	6.3	1BTS-1B035A-1K1B-1WK1B	947558A9			929041
	52	622	6.3	1BTS-1B060A-1K2B-1WK2B	947570A3			929041
								
	52	450	6.8	1BUTS-1B012A-1K3B-1WK3B	947552A5			929041
	52	450	6.8	1BUTS-1B035A-1K1B-1WK1B	947564A1			929041
	52	450	6.8	1BUTS-1B060A-1K2B-1WK2B	947576A7			929041

The transducer can be rotated for crowded multiple spindle arrangements (DGD 15° radial toothing). = maximum accessibility. Floating adapter not included with spindle.

2D and 3D are available to download at www.apexpowertools.com in the Customer Support section or on www.apexpowertools.eu in the download area.

BTS Models	Torque Range	Speed	Float	Square Drive
	Nm	RPM max.	mm	inch

Straight drive, single transducer

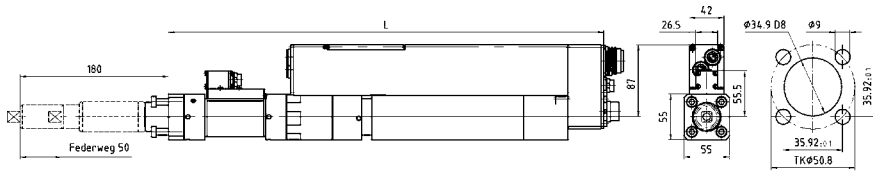

25-110	890	50	1/2"
40-200	502	50	3/4"

Straight drive with reversible gears, single transducer

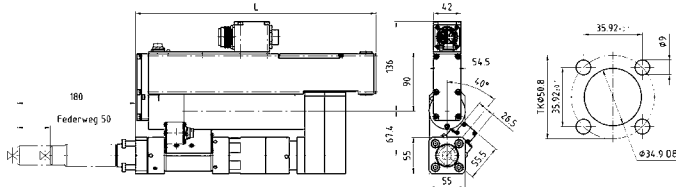

25-110	890	50	1/2"
40-200	502	50	3/4"

Offset drive, single transducer

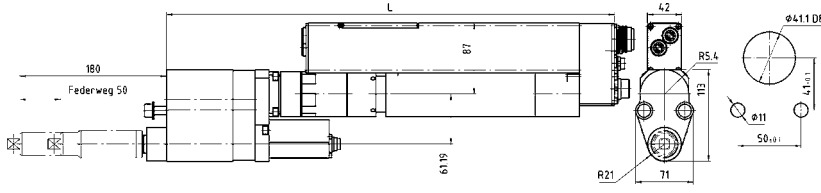

25-110	831	50	1/2"
40-200	468	50	3/4"

Offset drive with reversible gears, single transducer

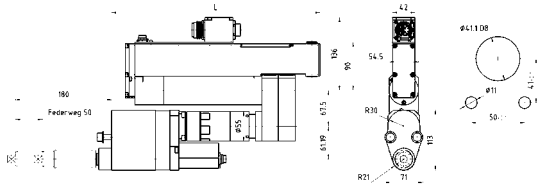

25-110	831	50	1/2"
40-200	468	50	3/4"

Angle drive, single transducer

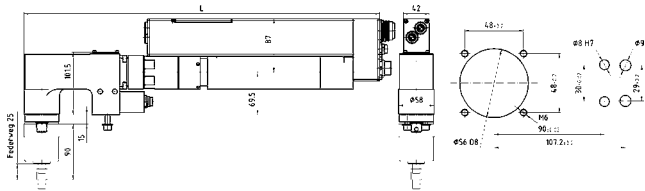





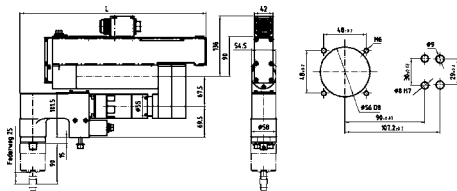











25-110	838	25	1/2"
40-200	472	25	3/4"

Angle drive with reversible gears, single transducer



25-110	838	25	1/2"
40-200	472	25	3/4"

Number of spindles	Smallest scribed circle diameter in mm		
	Model 2		
	Straight	Offset	Angle drive
2	56	44	59
3	75	50	68
4	80	62	86
5	106	74	101
6	130	89	118
7	151	102	137

	Min. Center-Center	L	Weight	Design	Order No. DGD Spindle	Floating Adapter		Floating Adapter incl. guide housing
	mm	mm	kg			Order No.	X (mm)	Order No.
								
	56	528	7.6	2BTS-2B110A-2K1B-2ZB	947517A8	910609	180	S308435
	56	528	7.6	2BTS-2B200A-2K3B-2ZB	947529A4	935552	180	S308450
								
	56	367	8.6	2BUTS-2B110A-2K1B-2ZB	947519A6	910609	180	S308435
	56	367	8.6	2BUTS-2B200A-2K3B-2ZB	947531A0	935552	180	S308450
								
	44	551	9.2	2BTS-2B110A-2VK1B	947521A2	910609	180	S308438
	44	551	9.2	2BTS-2B200A-2VK3B	947533A8	935552	180	S308475
								
	44	390	10.2	2BUTS-2B110A-2VK1B	947523A0	910609	180	S308438
	44	390	10.2	2BUTS-2B200A-2VK3B	947535A6	935552	180	S308475
								
	59	581	8.7	2BTS-2B110A-2WK1B	947525A8			929053
	59	581	8.7	2BTS-2B200A-2WK3B	947537A4			929061
								
	59	421	9.7	2BUTS-2B110A-2WK1B	947527A6			929053
	59	421	9.7	2BUTS-2B200A-2WK3B	947539A2			929061

The transducer can be rotated for crowded multiple spindle arrangements (DGD 15° radial toothing). = maximum accessibility. Floating adapter not included with spindle.

2D and 3D are available to download at www.apexpowertools.com in the Customer Support section or on www.apexpowertools.eu in the download area.

BTS Models	Torque Range	Speed	Float	Square Drive
		RPM		
	Nm	max.	mm	inch

Straight drive, twin transducer (redundant)

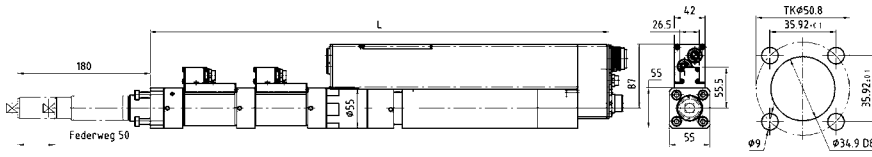

25-110	890	50	1/2"
40-200	502	50	3/4"

Straight drive with reversible gears, twin transducer (redundant)

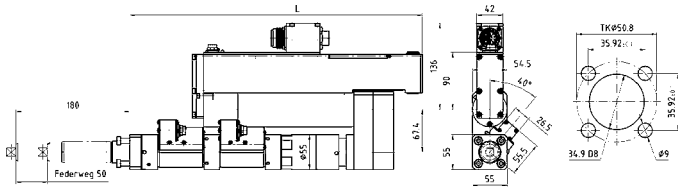

25-110	890	50	1/2"
40-200	502	50	3/4"

Offset drive, twin transducer (redundant)

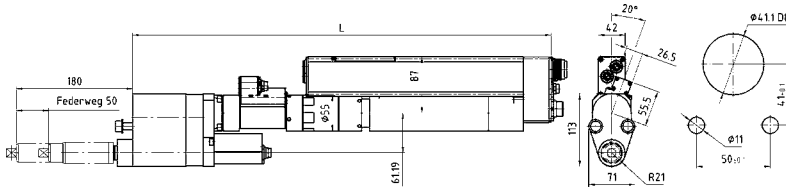

25-110	831	50	1/2"
40-200	468	50	3/4"

Offset drive with reversible gears, twin transducer (redundant)

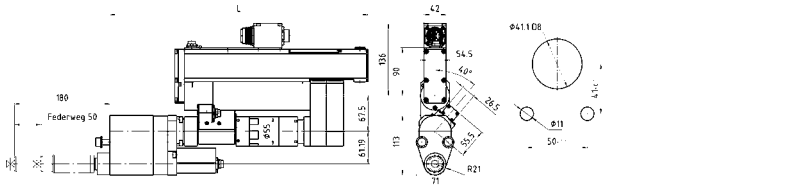

25-110	831	50	1/2"
40-200	468	50	3/4"

Angle drive, twin transducer (redundant)

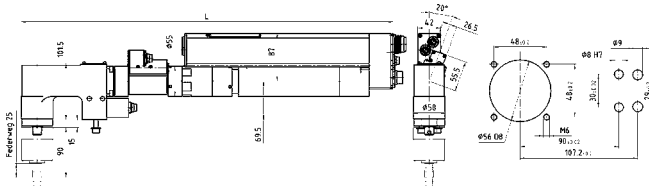

25-110	838	25	1/2"
40-200	472	25	3/4"

Angle drive with reversible gears, twin transducer (redundant)

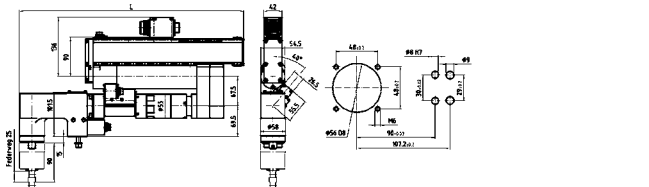

25-110	838	25	1/2"
40-200	472	25	3/4"

Smallest scribed circle diameter in mm				
Number of spindles	Model 2			
	Attachment			Angle drive
	Straight	Offset		
2	56	44		59
3	75	50		68
4	80	62		86
5	106	74		101
6	130	89		118
7	151	102		137

	Min. Center-Center	L	Weight	Design	Order No. DGD Spindle	Floating Adapter		Floating Adapter incl. guide housing
	mm	mm	kg			Order No.	X (mm)	Order No.
								
	56	625	8.7	2BTS-2B110A-2/2K1B-2ZB	947518A7	910609	180	S308435
	56	625	8.7	2BTS-2B200A-2/2K3B-2ZB	947530A1	935552	180	S308450
								
	56	464	9.7	2BUTS-2B110A-2/2K1B-2ZB	947520A3	910609	180	S308435
	56	464	9.7	2BUTS-2B200A-2/2K3B-2ZB	947532A9	935552	180	S308450
								
	44	648	10.3	2BTS-2B110A-2K1B-2VK1B	947522A1	910609	180	S308438
	44	648	10.3	2BTS-2B200A-2K3B-2VK3B	947534A7	935552	180	S308475
								
	44	487	11.3	2BUTS-2B110A-2K1B-2VK1B	947524A9	910609	180	S308438
	44	487	11.3	2BUTS-2B200A-2K3B-2VK3B	947536A5	935552	180	S308475
								
	59	678	9.8	2BTS-2B110A-2K1B-2WK1B	947526A7			929053
	59	678	9.8	2BTS-2B200A-2K3B-2WK3B	947538A3			929061
								
	59	518	9.7	2BUTS-2B110A-2K1B-2WK1B	947528A5			929053
	59	518	9.7	2BUTS-2B200A-2K3B-2WK3B	947540A9			929061

The transducer can be rotated for crowded multiple spindle arrangements (DGD 15° radial toothing). = maximum accessibility. Floating adapter not included with spindle.

2D and 3D are available to download at www.apexpowertools.com in the Customer Support section or on www.apexpowertools.eu in the download area.

BTS Models	Torque Range	Speed RPM	Float	Square Drive
	Nm	max.	mm	inch

Straight drive, single transducer

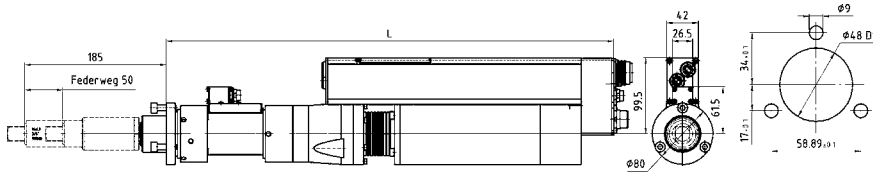

50-300	453	50	3/4"
--------	-----	----	------

Straight drive with reversible gears, single transducer

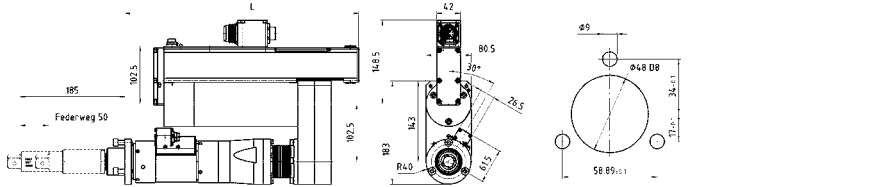

50-300	453	50	3/4"
--------	-----	----	------

versetzter Abtrieb, 1 Messwertaufnehmer / Offset drive, single transducer

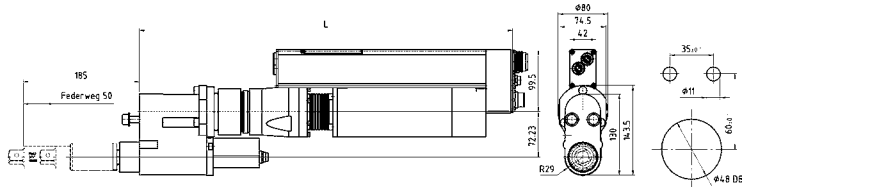

50-300	421	50	3/4"
--------	-----	----	------

Offset drive with reversible gears, single transducer

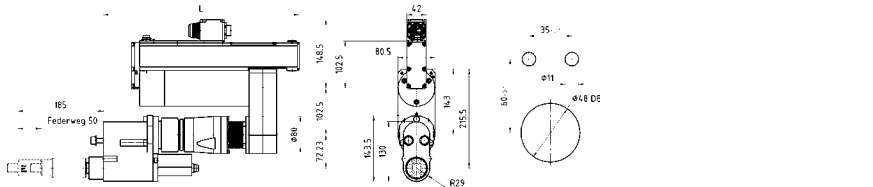

50-300	421	50	3/4"
--------	-----	----	------

Angle drive, single transducer

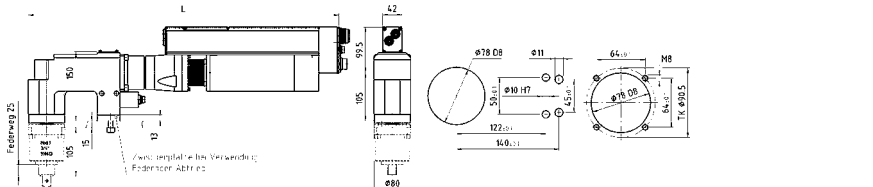

50-300	437	25	3/4"
--------	-----	----	------

Angle drive with reversible gears, single transducer

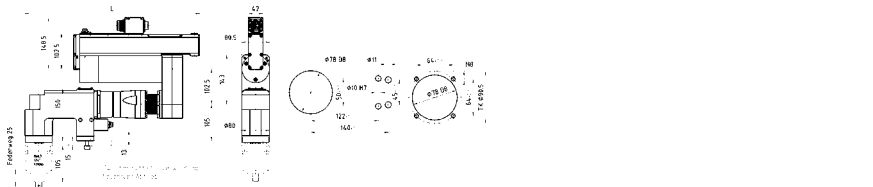

50-300	437	25	3/4"
--------	-----	----	------

Smallest scribed circle diameter in mm

Number of spindles	Model 3		
	Attachment		Angle drive
	Straight	Offset	
2	81	59	81
3	94	69	94
4	116	84	116
5	139	102	139
6	164	122	164
7	189	138	189

	Min. Center-Center	L	Weight	Design	Order No. DGD Spindle	Floating Adapter		Floating Adapter incl. guide housing
	mm	mm	kg			Order No.	X (mm)	Order No.
	81	589	14.1	3BTS-3B300A-3K2B-3ZB	947577A6	910613	185	S308436
	81	417	16.1	3BUTS-3B300A-3K2B-3ZB	947583A8	910613	185	S308436
	59	584	15.2	3BTS-3B300A-3VK2B	947579A4	910613	185	S308439
	59	412	17.2	3BUTS-3B300A-3VK2B	947585A6	910613	185	S308439
	81	678	17.8	3BTS-3B300A-3WK2B	947581A0			929065 <i>For angle attachment</i>
	81	506	19.8	3BUTS-3B300A-3WK2B	947587A4			929065 <i>For angle attachment</i>

The transducer can be rotated for crowded multiple spindle arrangements (DGD 15° radial toothing). = maximum accessibility. Floating adapter not included with spindle. 2D and 3D are available to download at www.apexpowertools.com in the Customer Support section or on www.apexpowertools.eu in the download area.

BTS Models	Torque Range	Speed	Float	Square Drive
	Nm	RPM max.	mm	inch

Straight drive, twin transducer (redundant)

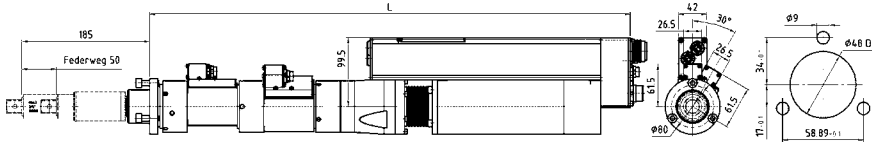

50-300	453	50	3/4"
--------	-----	----	------

Straight drive with reversible gears, twin transducer (redundant)

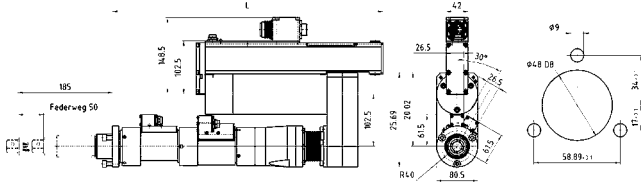

50-300	453	50	3/4"
--------	-----	----	------

Offset drive, twin transducer (redundant)

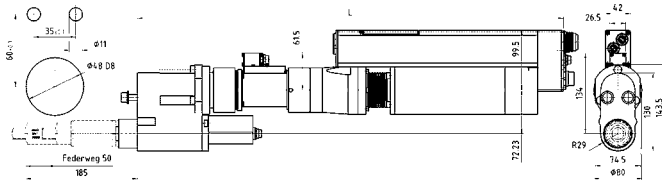

50-300	421	50	3/4"
--------	-----	----	------

Offset drive with reversible gears, twin transducer (redundant)

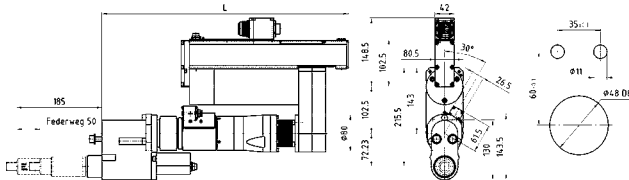

50-300	421	50	3/4"
--------	-----	----	------

Angle drive, twin transducer (redundant)

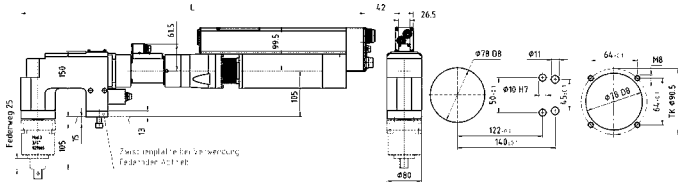

50-300	437	25	3/4"
--------	-----	----	------

Angle drive with reversible gears, twin transducer (redundant)

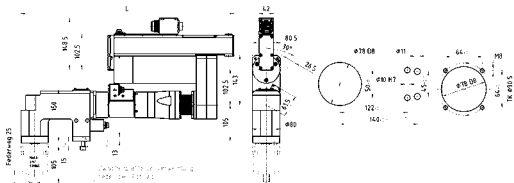

50-300	437	25	3/4"
--------	-----	----	------

Smallest scribed circle diameter in mm				
Number of spindles	Model 3			
	Attachment		Angle drive	
	Straight	Offset		
2	81	59	81	
3	94	69	94	
4	116	84	116	
5	139	102	139	
6	164	122	164	
7	189	138	189	

	Min. Center-Center	L	Weight	Design	Order No. DGD Spindle	Floating Adapter		Floating Adapter incl. guide housing
	mm	mm	kg			Order No.	X (mm)	Order No.
	81	701	16.2		947578A5		185	
	81	528	18.2		947584A7		185	
	59	696	17.3		947580A1		185	
	59	523	19.3		947586A5		185	
	81	790	19.9		947582A9			 <i>For angle attachment</i>
	81	617	21.9		947588A3			 <i>For angle attachment</i>

The transducer can be rotated for crowded multiple spindle arrangements (DGD 15° radial toothing). = maximum accessibility. Floating adapter not included with spindle. 2D and 3D are available to download at www.apexpowertools.com in the Customer Support section or on www.apexpowertools.eu in the download area.

BTS Models	Torque Range	Speed	Float	Square Drive
		RPM		
	Nm	max.	mm	inch

Straight drive, single transducer

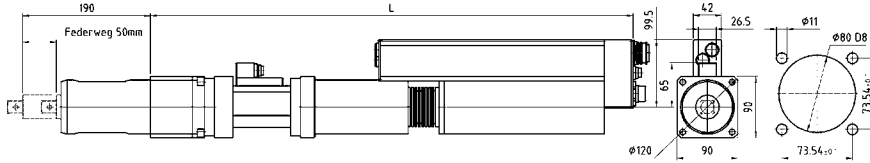

100-500	254	50	3/4"
130-660	174	50	1"
320-1250 ¹	86	50	1"
400-1600 ¹	68	50	1 1/2"

Straight drive with reversible gears, single transducer

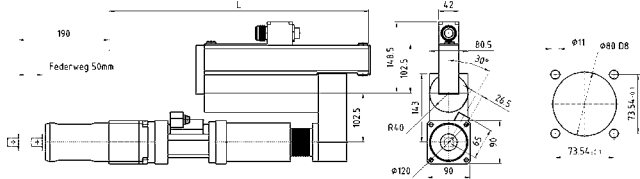

100-500	254	50	3/4"
130-660	174	50	1"
320-1250 ¹	86	50	1"
400-1600 ¹	68	50	1 1/2"

Offset drive, single transducer

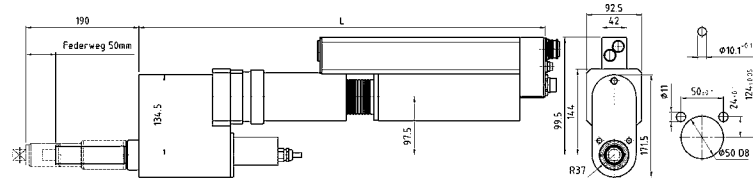

100-500	238	50	3/4"
130-660	163	50	1"
160-750	135	50	1"

Offset drive with reversible gears, single transducer

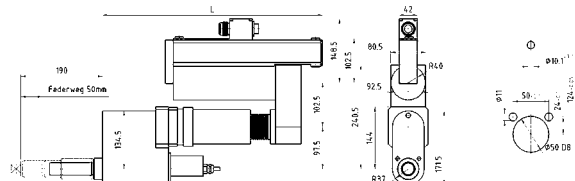

100-500	238	50	3/4"
130-660	163	50	1"
160-750	135	50	1"

Angle drive, single transducer

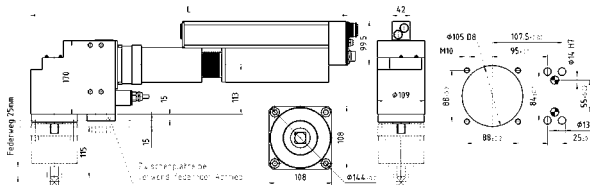

100-500	245	25	1"
130-660	167	25	1"

Angle drive with reversible gears, single transducer

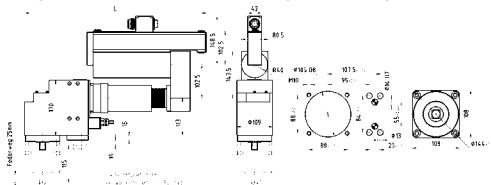















100-500	245	25	1"
130-660	167	25	1"

¹ Special version - technical drawings on request.

*2800 Nm spindle available on request.

Number of spindles	Smallest scribed circle diameter in mm			
	Model 4			
	Straight	Attachment **	Offset	Angle drive
2	91	121	76	112
3	122	152	88	130
4	130	172	108	160
5	174	230	130	192
6	217	281	153	224
7	246	327	180	263

	Min. Center-Center	L	Weight	Design	Order No. DGD Spindle	Floating Adapter		Floating Adapter incl. guide housing
	mm	mm	kg			Order No.	X (mm)	Order No.
								
91	719	21		4BTS-4B500A-4K2B-4ZA	947589A2	916643	190	
91	719	21		4BTS-4B660A-4K3B-4ZA	947601A5	916642	186	
121*	771	29		4BTS-4B360A-4K1B-4Z1250A	947617A7 ¹	S976956	140	
121*	771	29		4BTS-4B500A-4K2B-4Z1600A	947621A1 ¹	S308441	140	
								
91	546	22.5		4BUTS-4B500A-4K2B-4ZA	947595A4	916643	190	
91	546	22.5		4BUTS-4B660A-4K3B-4ZA	947609A7	916642	186	
121**	599	31		4BUTS-4B360A-4K1B-4Z1250A	947619A5 ¹	S976956	140	
121**	599	31		4BUTS-4B500A-4K2B-4Z1600A	947623A9 ¹	S308441	140	
								
76	684	22.5		4BTS-4B500A-4VK2B	947591A8	912106	190	S308440
76	684	22.5		4BTS-4B660A-4VK3B	947603A3	912147	186	S308474
76	684	23		4BTS-4B660A-4VK4B	947607A9	912147	186	S308474
								
76	512	24		4BUTS-4B500A-4VK2B	947597A2	912106	190	S308440
76	512	24		4BUTS-4B660A-4VK3B	947611A3	912147	186	S308474
76	512	24.5		4BUTS-4B660A-4VK4B	947615A9	912147	186	S308474
								 For angle attachment
112	729	27.1		4BTS-4B500A-4WK2B	947593A6			929089
112	729	27.1		4BTS-4B660A-4WK3B	947605A1			929089
								 For angle attachment
112	556	28.6		4BUTS-4B500A-4WK2B	947599A0			929089
112	556	28.7		4BUTS-4B660A-4WK3B	947613A1			929089

¹ Special version - technical drawings on request

The transducer can be rotated for crowded multiple spindle arrangements (DGD 15° radial toothing). = maximum accessibility. Floating adapter not included with spindle.

2D and 3D are available to download at www.apexpowertools.com in the Customer Support section or on www.apexpowertools.eu in the download area.

BTS Models	Torque Range	Speed	Float	Square Drive
		RPM		
	Nm	max.	mm	inch

Straight drive, twin transducer (redundant)

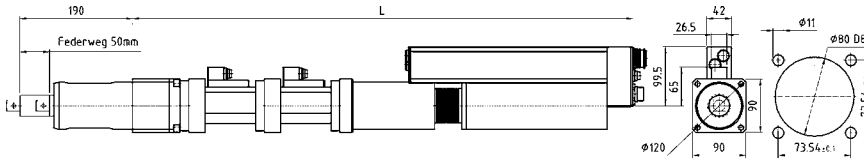

100-500	254	50	3/4"
130-660	174	50	1"
320-1250 ¹	86	50	1"
400-1600 ¹	68	50	1 1/2"

Straight drive with reversible gears, twin transducer (redundant)

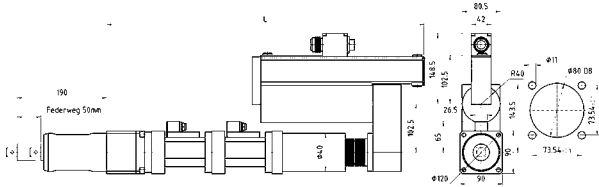

100-500	254	50	3/4"
130-660	174	50	1"
320-1250 ¹	86	50	1"
400-1600 ¹	68	50	1 1/2"

Offset drive, twin transducer (redundant)

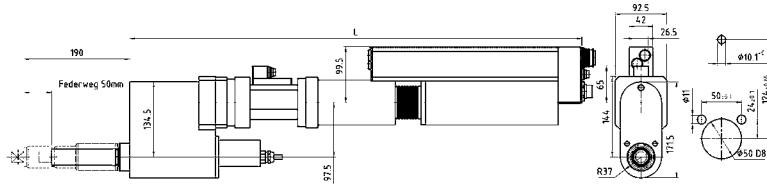

100-500	238	50	3/4"
130-660	163	50	1"
160-750	135	50	1"

Offset drive with reversible gears, twin transducer (redundant)

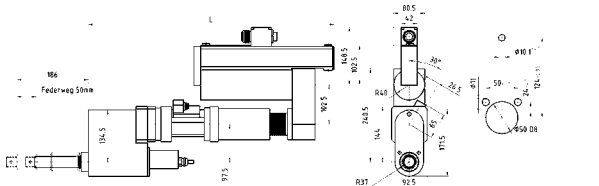

100-500	238	50	3/4"
130-660	163	50	1"
160-750	135	50	1"

Angle drive, twin transducer (redundant)

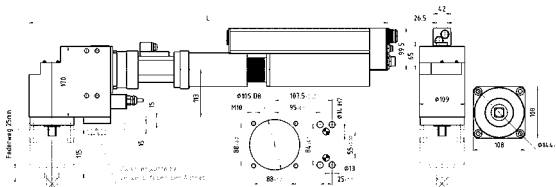

100-500	245	25	1"
130-660	167	25	1"

Angle drive with reversible gears, twin transducer (redundant)

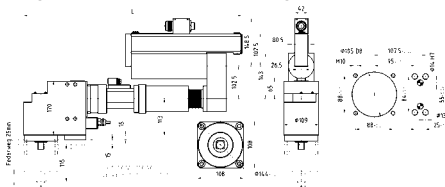













100-500	245	25	1"
130-660	167	25	1"

¹ Special version - technical drawings on request.

*2800 Nm spindle available on request.

Number of spindles	Smallest scribed circle diameter in mm			
	Model 4			
	Straight	Attachment **	Offset	Angle drive
2	91	121	76	112
3	122	152	88	130
4	130	172	108	160
5	174	230	130	192
6	217	281	153	224
7	246	327	180	263

	Min. Center-Center	L	Weight	Design	Order No. DGD Spindle	Floating Adapter		Floating Adapter incl. guide housing
	mm	mm	kg			Order No.	X (mm)	Order No.
								
	91	846	24	4BTS-4B500A-2/4K2B-4ZA	947590A9	916643	190	
	91	846	24	4BTS-4B660A-2/4K3B-4ZA	947602A4	916642	186	
	121**	899	32	4BTS-4B360A-2/4K1B-4Z1250A	947618A6 ¹	S976956	140	
	121**	899	32	4BTS-4B500A-2/4K2B-4Z1600A	947622A0 ¹	S308441	140	
								
	91	674	25.5	4BUTS-4B500A-2/4K2B-4ZA	947596A3	916643	190	
	91	674	25.5	4BUTS-4B660A-2/4K3B-4ZA	947610A4	916642	186	
	121**	726	34	4BUTS-4B360A-2/4K1B-4Z1250A	947620A2 ¹	S976956	140	
	121**	726	34	4BUTS-4B500A-2/4K2B-4Z1600A	947624A8 ¹	S308441	140	
								
	76	812	25.5	4BTS-4B500A-4K2B-4VK2B	947592A7	912106	190	S308440
	76	812	25.5	4BTS-4B660A-4K3B-4VK3B	947604A2	912147	186	S308474
	76	812	26	4BTS-4B660A-4K3M-4VK4B	947608A8	912147	186	S308474
								
	76	639	27	4BUTS-4B500A-4K2B-4VK2B	947598A1	912106	186	S308440
	76	639	27	4BUTS-4B660A-4K3B-4VK3B	947612A2	912147	181	S308474
	76	639	27.5	4BUTS-4B660A-4K3M-4VK4B	947616A8	912147	181	S308474
								
	112	856	30.1	4BTS-4B500A-4K2B-4WK2B	947594A5			929089
	112	856	30.1	4BTS-4B660A-4K3B-4WK3B	947606A0			929089
								
	112	684	31.6	4BUTS-4B500A-4K2B-4WK2B	947600A6			929089
	112	684	31.7	4BUTS-4B660A-4K3B-4WK3B	947614A0			929089

¹ Special version - technical drawings on request

The transducer can be rotated for crowded multiple spindle arrangements (DGD 15° radial toothing). = maximum accessibility. Floating adapter not included with spindle.

2D and 3D are available to download at www.apexpowertools.com in the Customer Support section or on www.apexpowertools.eu in the download area.

Intelligent Spindles

Accessories

Versatility To Work With Many Tool Configurations

DGD Intelligent Spindles can be used in conjunction with any Cleco DC electric tool combination – cordless LiveWire or corded handheld – and with the mPro400GC Global Controller for even greater efficiencies.

Cleco Global Controllers for Intelligent Spindles

Description	Tool Compatibility	Model
Primary Master	Cleco 18-48 Series, LiveWire, Intelligent Spindle*	MPRO400GC-P
Master	LiveWire, Intelligent Spindle*	MPRO400GC-M
Panel Mount	LiveWire, Intelligent Spindle	MPRO400GC-SG

* Requires quote to accommodate hardware configurations.



Connection & Extension Cables For Intelligent Spindles

HighFlex Quality

- For fixed or flexible routing with heavy-duty requirements in applications with cable drag chain or standard robot applications

SuperHighFlex Quality

- For robot and all high mobility applications (high durability) with complex motion-sequences
- Available on request

mPro400GC-M



System Bus Cable

Jumper Cables between nutrunners (straight connector)

Primary Field Cable, direct connection between nutrunner and fastening control (straight connector)



Bus-Terminator 961127

CPM3

System Cables for Intelligent Spindle

System Bus Cables

Description	Length* (m)	Order No.
System Bus Cable	0.5	544196-005
System Bus Cable	2.0	544196-020
System Bus Cable	5.0	544196-050
System Bus Cable	20.0	544196-200
System Bus Cable	50.0	544196-500

*The cable lengths are specified in decimeters at the end of the order number

Jumper Cables

Description	Length* (m)	Order No.
-------------	-------------	-----------

Highflex Type D (Jumper) straight connector on both sides moulded connector housing

	0.5	961104-005
	1.0	961104-010
	2.0	961104-020

Highflex Type E (Jumper) 90° connector on both sides rotatable cable glands

	0.5	961299-005
	1.0	961299-010
	2.0	961299-020

*The cable lengths are specified in decimeters at the end of the order number. Other cable length on request.

Primary Field Cables

Description	Length* (m)	Order No.
Highflex Type A Straight connector on both sides	0,5	961104-005
	1	961104-010
	2	961104-020
	3	961104-030
	4	961104-040
	5	961104-050
	6	961104-060
	7	961104-070
	8	961104-080
	9	961104-090
	10	961104-100
	15	961104-150
	20	961104-200
	30	961104-300
	40	961104-400
50	961104-500	

*The cable lengths are specified in decimeters at the end of the order number

Power Table

Overview of possible numbers of channels

The maximum number of DGD Intelligent Spindles per mPro400GC Controller depends on load. When calculating the maximum number of spindles, please consider the following conditions:

- Maximum speed at 20% of maximum torque (at 1BTSE, 2BTSE, 3BTSE and 4BTSE)
- Final tightening stage up to 500 Nm Maximal Speed 50 rpm at maximum torque (at 1BTSE, 2BTSE, 3BTSE and 4BTSE-4B500A..)

- Final tightening stage over 500 Nm Maximal Speed 20 rpm at maximum torque (at 4BTSE-4B660A..., 4BTSE-4B660A-4VK4MS, 4BTSE-4B360A-4Z1250A and 4BTSE-4B460A-4Z1600A)

If higher settings are chosen, number of channels should be reduced.

If different spindle types are used at the controller, the number of channels will be individually defined.

Please contact Apex Tool Group.

Control Type	Maximum number of DGD Intelligent Spindles				Number of cables to fastening control	Comments
	1BTSE...	2BTSE...	3BTSE...	4BTSE...		
CPM3	16	6	6	6	1	OC=Outside Controller
CPM3	16	6	6	6	1	H=With Archnet
CPM6	32	12	12	12	2	Archnet Hub Included
CPM9	...	18	18	18	3	Archnet Hub Included
Control Panel	...	32	32	32	...	Archnet Hub Included

Power Distribution System

The Power Distribution System is used in conjunction with the Intelligent Spindles. This system is used for power distribution. Includes standard hardware such as E stop circuitry, 24VDC power supply, line filter, CPM, necessary relays, disconnect and viewing window. External power transformer is required.

Power Distribution System	Part No.
CPM3	PDB-CPS3
CPM6	PDB-CPS6
CPM9	PDB-CPS9



CPM3 With Internal Power Transformer and Without Viewing Window

Contact your local Application Center for more information.



CPS6 / CPS9 With mPro400-SG and Internal Power Transformer

Contact your local Application Center for more information.

Power Control Package

Each Power Control Package consists of the following:

- mPro400 GC-M Global Controller
- PDB-CPS X power distribution box with viewing window
- Power transformer
- Stand



Part Number

- MPRO400GCMPCPS3A
- MPRO400GCMPCPS3T
- MPRO400GCMPCPS6A
- MPRO400GCMPCPS6T
- MPRO400GCMPCPS9A
- MPRO400GCMPCPS9T

T=PLC Siemens S7 for additional I/O

Torque Transducer Verification Fixture (TTVF)

Fast, accurate, cost effective way to verify your torque transducer on the assembly line measure. Included is a joint simulator, slip ring torque transducer and spindle adapter. The joint simulator can be mounted to a tooling plate or mounted to the spindle directly. Any data recorder with the proper interface can be used.

Torque Range (Nm)	Part No.
2-23	579900PT-23
6-68	579900PT-68
20-200	579900PT-200
50-500	579900PT-500
100-1000	579900PT-1000



DGD Fixtured Spindles

Size 1, Single Transducer (torque+angle)

2 - 53 Nm

	Torque Range	Speed RPM	Float	Square Drive
	Nm	max.	mm	inch

Straight drive, single transducer

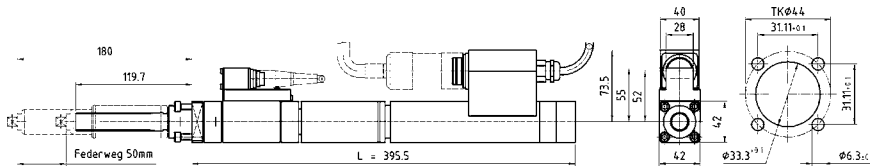

2-11	1222	50	3/8"
5-32	462	50	3/8"
15-53	272	50	3/8"

Straight drive with reversible gears, single transducer

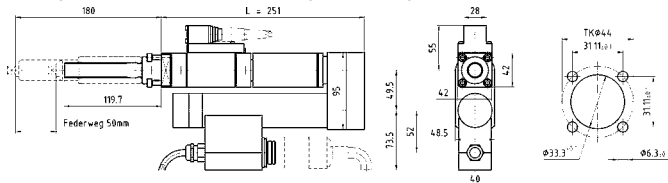

2-11	1222	50	3/8"
5-32	462	50	3/8"
15-53	272	50	3/8"

Offset drive, single transducer

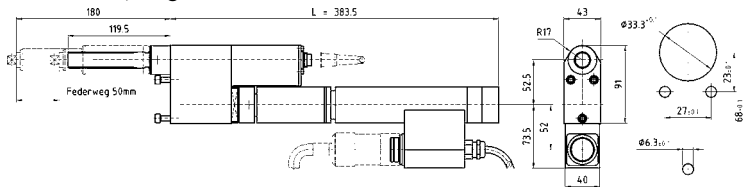

2-11	1161	50	3/8"
5-32	439	50	3/8"
15-53	258	50	3/8"

Offset drive with reversible gears, single transducer

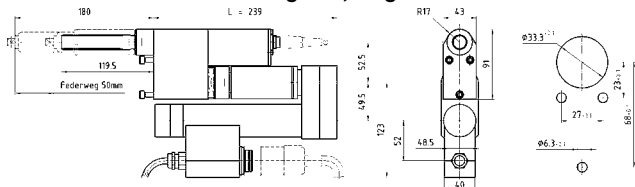

2-11	1161	50	3/8"
5-32	439	50	3/8"
15-53	258	50	3/8"

Angle drive, single transducer

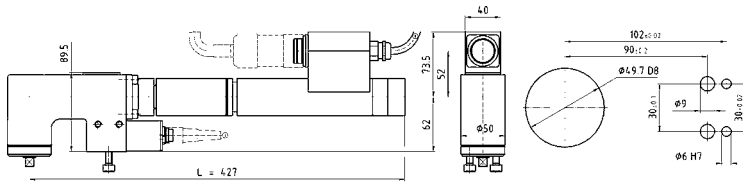





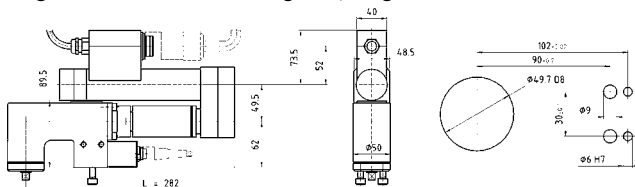











2-11	1146	25	3/8"
5-32	434	25	3/8"
15-53	255	25	3/8"

Angle drive with reversible gears, single transducer



2-11	1146	25	3/8"
5-32	434	25	3/8"
15-53	255	25	3/8"

Number of spindles	Smallest scribed circle diameter in mm		
	Model 1		
	Straight	Offset	Angle drive
2	43	35	52
3	54	40	60
4	61	50	74
5	81	58	89
6	99	70	105
7	116	85	120

	Min. Center-Center	L	Weight	Design	Order No. DGD Spindle	Floating Adapter		Floating Adapter incl. guide housing
	mm	mm	kg			Order No.	X (mm)	Order No.
								
	43	396	3.5	1BB-1B011A-1K3MS-1ZA	7348126117	922325PT	180	S308434
	43	396	3.5	1BB-1B030A-1K1M-1ZA	946775C8	922325PT	180	S308434
	43	396	3.5	1BB-1B050A-1K2M-1ZA	946779C4	922325PT	180	S308434
								
	43	251	4.0	1BUB-1B011A-1K3MS-1ZA	7348126145	922325PT	180	S308434
	43	251	4.0	1BUB-1B030A-1K1M-1ZA	946840C8	922325PT	180	S308434
	43	251	4.0	1BUB-1B050A-1K2M-1ZA	946844C4	922325PT	180	S308434
								
	35	384	4.0	1BB-1B011A-1VK3MS	7348126126	922325PT	180	S308437
	35	384	4.0	1BB-1B030A-1VK1M	946777C6	922325PT	180	S308437
	35	384	4.0	1BB-1B050A-1VK2M	946781C0	922325PT	180	S308437
								
	35	239	4.5	1BUB-1B011A-1VK3MS	7348126146	922325PT	180	S308437
	35	239	4.5	1BUB-1B030A-1VK1M	946842C6	922325PT	180	S308437
	35	239	4.5	1BUB-1B050A-1VK2M	946846C2	922325PT	180	S308437
								
	52	427	4.4	1BB-1B011A-1WK3MS	7348126125			929041
	52	427	4.4	1BB-1B030A-1WK1M	946884C6			929041
	52	427	4.4	1BB-1B050A-1WK2M	946888C2			929041
								
	52	282	4.9	1BUB-1B011A-1WK3MS	7348126147			929041
	52	282	4.9	1BUB-1B030A-1WK1M	946886C4			929041
	52	282	4.9	1BUB-1B050A-1WK2M	946890C8			929041

The transducer can be rotated for crowded multiple spindle arrangements (DGD 15° radial toothing).

= maximum accessibility. Floating adapter not included with spindle.

2D and 3D are available to download at www.apexpowertools.com in the Customer Support section or on www.apexpowertools.eu in the download area.

DGD Fixtured Spindles

Size 1, Twin Transducer (redundant) - (2x torque + 2x angle)

2 - 53 Nm

Torque Range	Speed	Float	Square Drive
	RPM		
Nm	max.	mm	inch

Straight attachment, twin transducer (redundant)

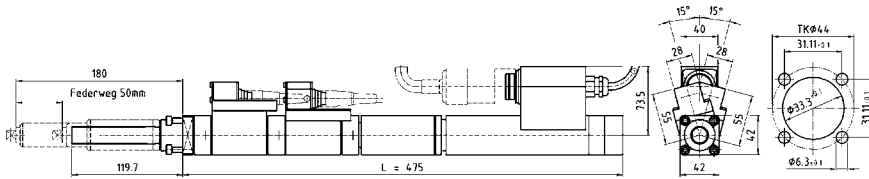

2-11	1222	50	3/8"
5-32	462	50	3/8"
15-53	272	50	3/8"

Straight attachment with reversible gears, twin transducer (redundant)

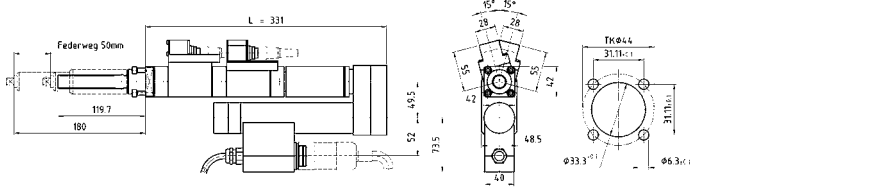

2-11	1222	50	3/8"
5-32	462	50	3/8"
15-53	272	50	3/8"

Offset attachment, twin transducer (redundant)

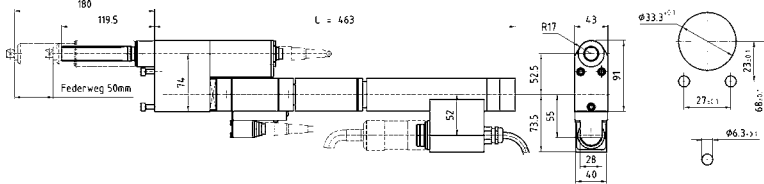

2-11	1161	50	3/8"
5-32	439	50	3/8"
15-53	258	50	3/8"

Offset attachment with reversible gears, twin transducer (redundant)

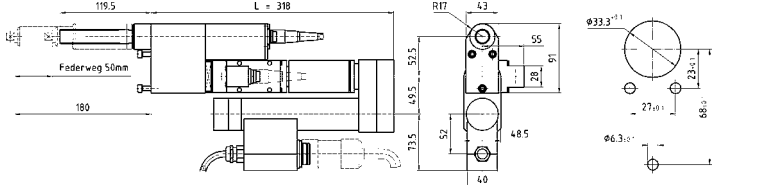

2-11	1161	50	3/8"
5-32	439	50	3/8"
15-53	258	50	3/8"

Angle attachment, twin transducer (redundant)

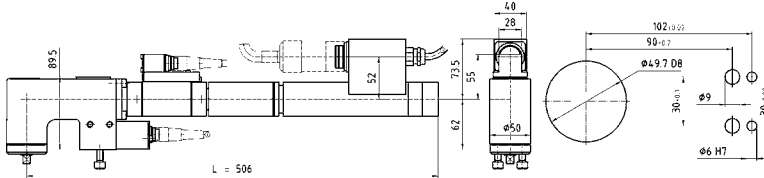





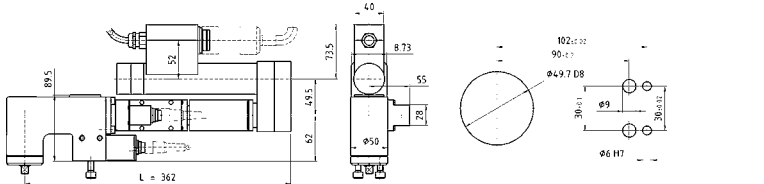











2-11	1146	25	3/8"
5-32	434	25	3/8"
15-53	255	25	3/8"

Angle attachment with reversible gears, twin transducer (redundant)



2-11	1146	25	3/8"
5-32	434	25	3/8"
15-53	255	25	3/8"

Number of spindles	Smallest scribed circle diameter in mm		
	Model 1		
	Attachment		Angle drive
Straight	Offset		
2	43	35	52
3	54	40	60
4	61	50	74
5	81	58	89
6	99	70	105
7	116	85	120

	Min. Center-Center	L	Weight	Design	Order No. DGD Spindle	Floating Adapter		Floating Adapter incl. guide housing
	mm	mm	kg			Order No.	X (mm)	Order No.
								
	43	476	4.1	1BB-1B011A-2/1K3MS-1ZA	7348126124	922325PT	180	S308434
	43	476	4.1	1BB-1B030A-2/1K1M-1ZA	946776C7	922325PT	180	S308434
	43	476	4.1	1BB-1B050A-2/1K2M-1ZA	946780C1	922325PT	180	S308434
								
	43	331	4.6	1BUB-1B011A-2/1K3MS-1ZA	7348126148	922325PT	180	S308434
	43	331	4.6	1BUB-1B030A-2/1K1M-1ZA	946841C7	922325PT	180	S308434
	43	331	4.6	1BUB-1B050A-2/1K2M-1ZA	946845C3	922325PT	180	S308434
								
	35	464	4.6	1BB-1B011A-1K3MS-1VK3MS	7348126149	922325PT	180	S308437
	35	464	4.6	1BB-1B030A-1K1M-1VK1M	946778D3	922325PT	180	S308437
	35	464	4.6	1BB-1B050A-1K2M-1VK2M	946782D7	922325PT	180	S308437
								
	35	319	5.1	1BUB-1B011A-1K3MS-1VK3MS	7348126150	922325PT	180	S308437
	35	319	5.1	1BUB-1B030A-1K1M-1VK1M	946843D3	922325PT	180	S308437
	35	319	5.1	1BUB-1B050A-1K2M-1VK2M	946847D9	922325PT	180	S308437
								
	52	507	5.0	1BB-1B011A-1K3MS-1WK3MS	7348126151			929041
	52	507	5.0	1BB-1B030A-1K1M-1WK1M	946885D3			929041
	52	507	5.0	1BB-1B050A-1K2M-1WK2M	946889D9			929041
								
	52	362	5.5	1BUB-1B011A-1K3MS-1WK3MS	7348126152			929041
	52	362	5.5	1BUB-1B030A-1K1M-1WK1M	946887D1			929041
	52	362	5.5	1BUB-1B050A-1K2M-1WK2M	946891D5			929041

The transducer can be rotated for crowded multiple spindle arrangements (DGD 15° radial toothing).

= maximum accessibility. Floating adapter not included with spindle.

2D and 3D are available to download at www.apexpowertools.com in the Customer Support section or on www.apexpowertools.eu in the download area.

DGD Fixtured Spindles

Size 2, Single Transducer (torque+angle)

25 - 153 Nm

	Torque Range	Speed	Float	Square Drive
		RPM		
	Nm	max.	mm	inch

Straight drive, single transducer

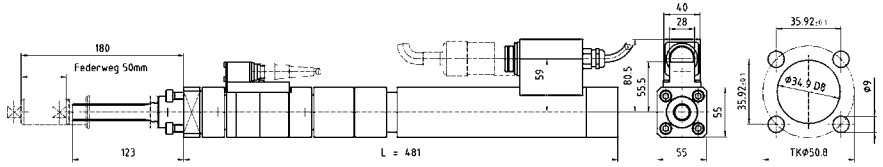

25-102	329	50	1/2"
30-153	219	50	1/2"

Straight drive with reversible gears, single transducer

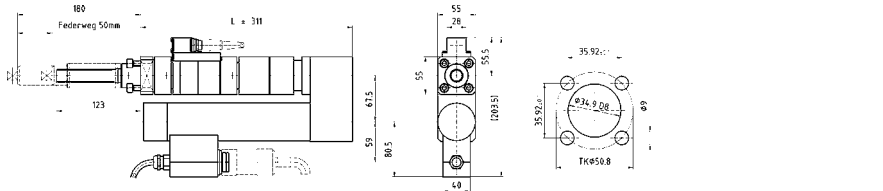

25-102	329	50	1/2"
30-153	219	50	1/2"

Offset drive, single transducer

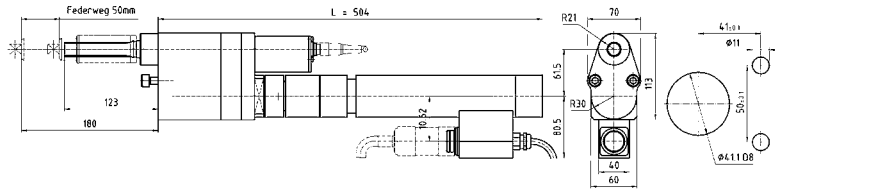

25-102	307	50	1/2"
30-153	204	50	1/2"

Offset drive with reversible gears, single transducer

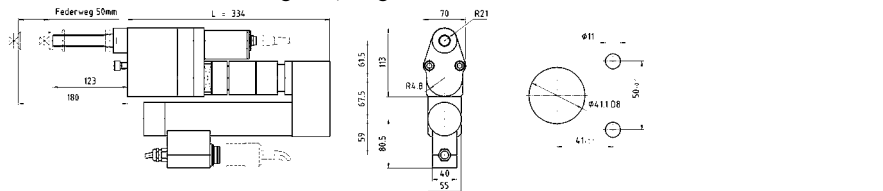

25-102	307	50	1/2"
30-153	204	50	1/2"

Angle drive, single transducer

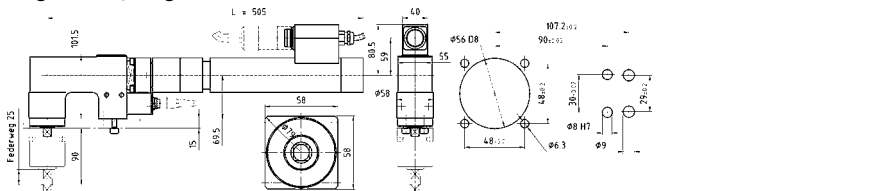





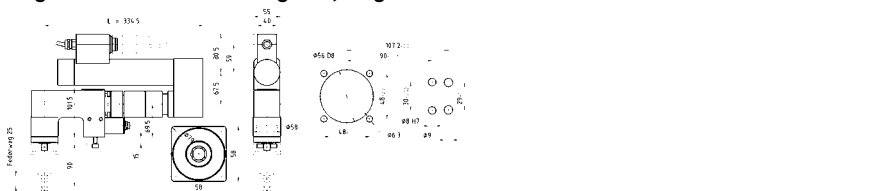











25-102	310	25	1/2"
30-153	206	25	1/2"

Angle drive with reversible gears, single transducer



25-102	310	25	1/2"
30-153	206	25	1/2"

Number of spindles	Smallest scribed circle diameter in mm		
	Model 2		
	Straight	Attachment	Angle drive
2	56	44	59
3	75	50	68
4	80	62	86
5	106	74	101
6	130	89	118
7	151	102	137

	Min. Center-Center	L	Weight	Design	Order No. DGD Spindle	Floating Adapter		Floating Adapter incl. guide housing
	mm	mm	kg			Order No.	X (mm)	Order No.
								
	56	481	6,5	2BB-2B100A-2K1M-2ZA	946783C8	910609	180	S308435
	56	481	6,5	2BB-2B150A-2K2M-2ZA	946787C4	910609	180	S308435
								
	56	310	7,5	2BUB-2B100A-2K1M-2ZA	946832C8	910609	180	S308435
	56	310	7,5	2BUB-2B150A-2K2M-2ZA	946836C4	910609	180	S308435
								
	44	504	8,1	2BB-2B100A-2VK1M	946785C6	910609	180	S308438
	44	504	8,1	2BB-2B150A-2VK2M	946789C2	910609	180	S308438
								
	44	333	9,1	2BUB-2B100A-2VK1M	946834C6	910609	180	S308438
	44	333	9,1	2BUB-2B150A-2VK2M	946838C2	910609	180	S308438
								
	59	505	7,6	2BB-2B100A-2WK1M	946900C5			929053
	59	505	7,6	2BB-2B150A-2WK2M	946904C1			929053
								
	59	335	8,6	2BUB-2B100A-2WK1M	946902C3			929053
	59	335	8,6	2BUB-2B150A-2WK2M	946906C9			929053

The transducer can be rotated for crowded multiple spindle arrangements (DGD 15° radial toothing).
= maximum accessibility. Floating adapter not included with spindle.

2D and 3D are available to download at www.apexpowertools.com in the Customer Support section or on www.apexpowertools.eu in the download area.

DGD Fixtured Spindles

Size 2, Twin Transducer (redundant) - (2x torque + 2x angle)

25 - 153 Nm

	Torque Range	Speed RPM	Float	Square Drive
	Nm	max.	mm	inch

Straight attachment, twin transducer (redundant)

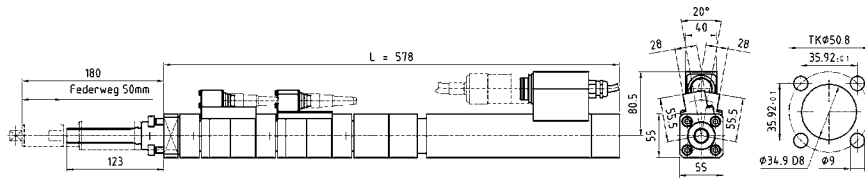

25-102	329	50	1/2"
30-153	219	50	1/2"

Straight attachment with reversible gears, twin transducer (redundant)

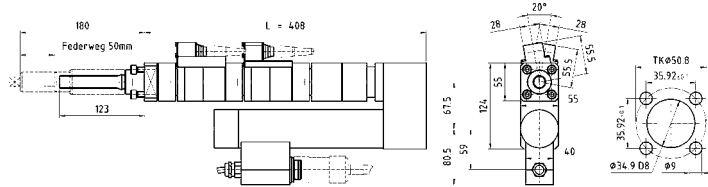

25-102	329	50	1/2"
30-153	219	50	1/2"

Offset attachment, twin transducer (redundant)

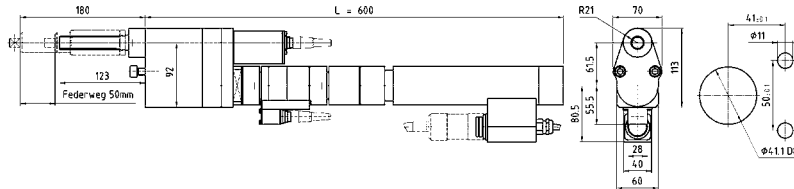

25-102	307	50	1/2"
30-153	204	50	1/2"

Offset attachment with reversible gears, twin transducer (redundant)

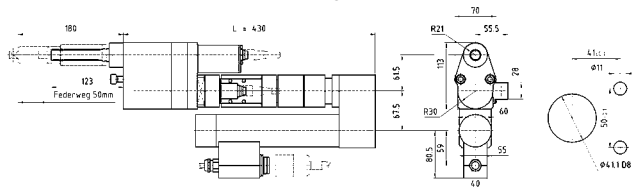

25-102	307	50	1/2"
30-153	204	50	1/2"

Angle attachment, twin transducer (redundant)

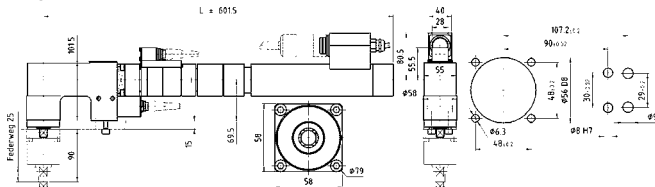





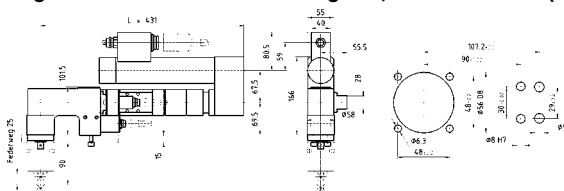











25-102	310	25	1/2"
30-153	206	25	1/2"

Angle attachment with reversible gears, twin transducer (redundant)



25-102	310	25	1/2"
30-153	206	25	1/2"

Number of spindles	Smallest scribed circle diameter in mm		
	Model 2		
	Straight	Attachment	Angle drive
2	56	44	59
3	75	50	68
4	80	62	86
5	106	74	101
6	130	89	118
7	151	102	137

	Min. Center-Center	L	Weight	Design	Order No. DGD Spindle	Floating Adapter		Floating Adapter incl. guide housing
	mm	mm	kg			Order No.	X (mm)	Order No.
								
	56	578	7.6	2BB-2B100A-2/2K1M-2ZA	946784C7	910609	180	S308435
	56	578	7.6	2BB-2B150A-2/2K2M-2ZA	946788C3	910609	180	S308435
								
	56	407	8.6	2BUB-2B100A-2/2K1M-2ZA	946833C7	910609	180	S308435
	56	407	8.6	2BUB-2B150A-2/2K2M-2ZA	946837C3	910609	180	S308435
								
	44	601	9.2	2BB-2B100A-2K1M-2VK1M	946786D3	910609	180	S308438
	44	601	9.2	2BB-2B150A-2K2M-2VK2M	946790D7	910609	180	S308438
								
	44	430	10.2	2BUB-2B100A-2K1M-2VK1M	946835D3	910609	180	S308438
	44	430	10.2	2BUB-2B150A-2K2M-2VK2M	946839D9	910609	180	S308438
								
	59	602	8.7	2BB-2B100A-2K1M-2WK1M	946901D2			929053
	59	602	8.7	2BB-2B150A-2K2M-2WK2M	946905D8			929053
								
	59	432	9.7	2BUB-2B100A-2K1M-2WK1M	946903D0			929053
	59	432	9.7	2BUB-2B150A-2K2M-2WK2M	946907D6			929053

The transducer can be rotated for crowded multiple spindle arrangements (DGD 15° radial toothing).
= maximum accessibility. Floating adapter not included with spindle.

2D and 3D are available to download at www.apexpowertools.com in the Customer Support section or on www.apexpowertools.eu in the download area.

DGD Fixtured Spindles

Size 3, Single Transducer (torque+angle)

30 - 260 Nm

	Torque Range	Speed	Float	Square Drive
	Nm	RPM max.	mm	inch

Straight drive, single transducer

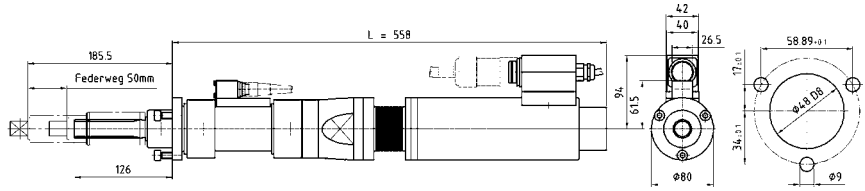

30-180	339	50	3/4"
50-260	220	50	3/4"

Straight drive with reversible gears, single transducer

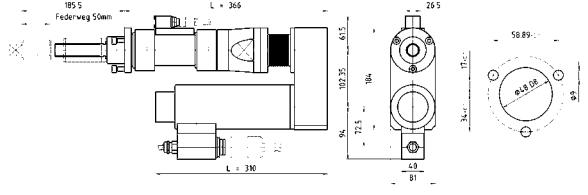

30-180	339	50	3/4"
50-260	220	50	3/4"

Offset drive, single transducer

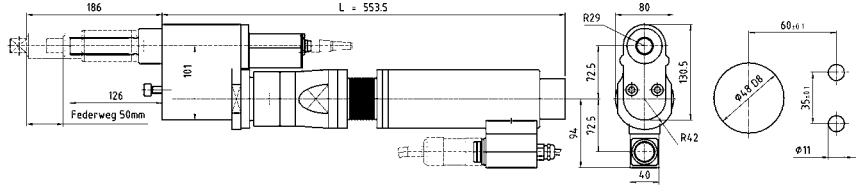

30-180	315	50	3/4"
50-260	204	50	3/4"

Offset drive with reversible gears, single transducer

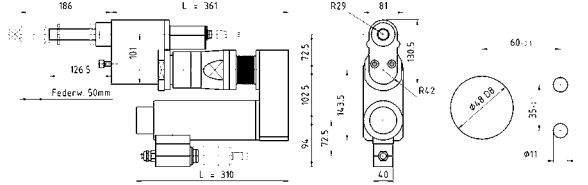

30-180	315	50	3/4"
50-260	204	50	3/4"

Angle drive, single transducer

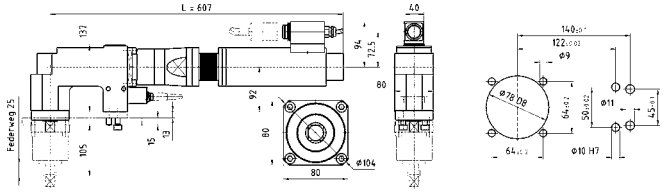

30-180	327	25	3/4"
50-260	211	25	3/4"



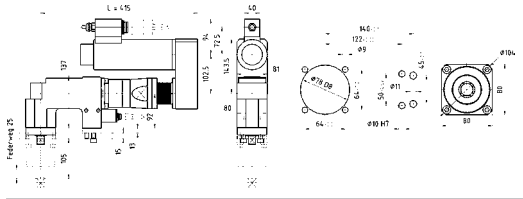













Angle drive with reversible gears, single transducer



30-180	327	25	3/4"
50-260	211	25	3/4"

Smallest scribed circle diameter in mm

Number of spindles	Model 3		
	Attachment		Angle drive
	Straight	Offset	
2	81	59	81
3	94	69	94
4	116	84	116
5	139	102	139
6	164	122	164
7	189	138	189

	Min. Center-Center	L	Weight	Design	Order No. DGD Spindle	Floating Adapter		Floating Adapter incl. guide housing
	mm	mm	kg			Order No.	X (mm)	Order No.
								
	81	558	13.1	3BB-3B180A-3K1M-3ZA	946816C8	910613	185	S308436
	81	558	13.1	3BB-3B260A-3K2M-3ZA	946818C6	910613	185	S308436
								
	81	366	15.1	3BUB-3B180A-3K1M-3ZA	946824C8	910613	185	S308436
	81	366	15.1	3BUB-3B260A-3K2M-3ZA	946826C6	910613	185	S308436
								
	59	553	14.2	3BB-3B180A-3VK1M	946820C2	910613	185	S308439
	59	553	14.2	3BB-3B260A-3VK2M	946822C0	910613	185	S308439
								
	59	361	16.1	3BUB-3B180A-3VK1M	946828C4	910613	185	S308439
	59	361	16.1	3BUB-3B260A-3VK2M	946830C0	910613	185	S308439
								
	81	607	16.8	3BB-3B180A-3WK1M	946916C7			929065
	81	607	16.8	3BB-3B260A-3WK2M	946920C1			929065
								
	81	415	18.8	3BUB-3B180A-3WK1M	946918C5			929065
	81	415	18.8	3BUB-3B260A-3WK2M	946922C9			929065

The transducer can be rotated for crowded multiple spindle arrangements (DGD 15° radial toothing).

= maximum accessibility. Floating adapter not included with spindle.

2D and 3D are available to download at www.apexpowertools.com in the Customer Support section or on www.apexpowertools.eu in the download area.

DGD Fixtured Spindles

Size 3, Twin Transducer (redundant) - (2x torque + 2x angle)

30 - 260 Nm

	Torque Range	Speed	Float	Square Drive
		RPM		
	Nm	max.	mm	inch

Straight attachment, twin transducer (redundant)

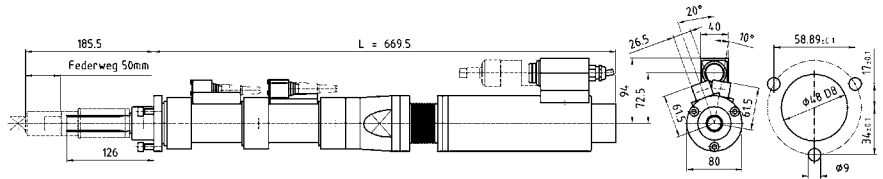

30-180	339	50	3/4"
50-260	220	50	3/4"

Straight attachment with reversible gears, twin transducer (redundant)

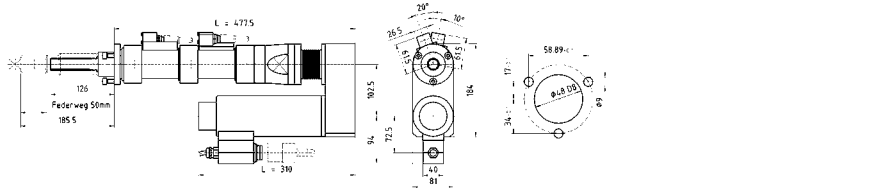

30-180	339	50	3/4"
50-260	220	50	3/4"

Offset attachment, twin transducer (redundant)

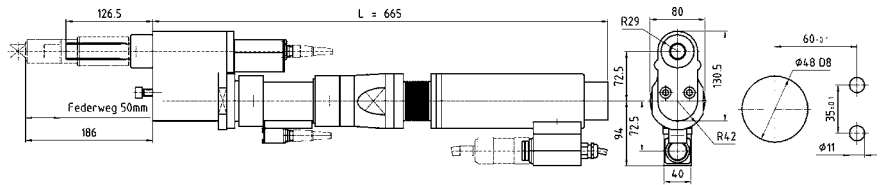

30-180	315	50	3/4"
50-260	204	50	3/4"

Offset attachment with reversible gears, twin transducer (redundant)

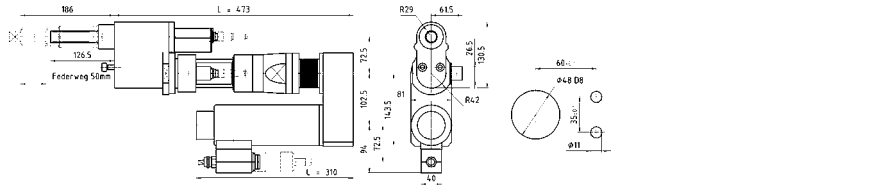

30-180	315	50	3/4"
50-260	204	50	3/4"

Angle attachment, twin transducer (redundant)

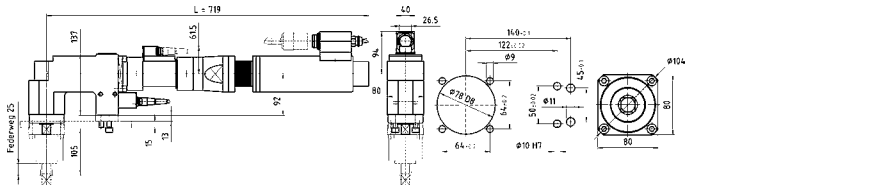





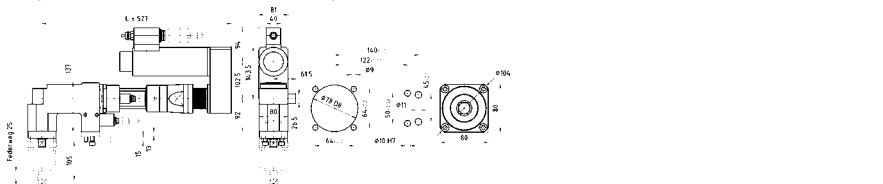











30-180	327	25	3/4"
50-260	211	25	3/4"

Angle attachment with reversible gears, twin transducer (redundant)



30-180	327	25	3/4"
50-260	211	25	3/4"

Number of spindles	Smallest scribed circle diameter in mm		
	Model 3		
	Attachment		Angle drive
Straight	Offset		
2	81	59	81
3	94	69	94
4	116	84	116
5	139	102	139
6	164	122	164
7	189	138	189

	Min. Center-Center	L	Weight	Design	Order No. DGD Spindle	Floating Adapter		Floating Adapter incl. guide housing
	mm	mm	kg			Order No.	X (mm)	Order No.
								
	81	670	15.2	3BB-3B180A-2/3K1M-3ZA	946817C7	910613	185	S308436
	81	670	15.2	3BB-3B260A-2/3K2M-3ZA	946819C5	910613	185	S308436
								
	81	478	17.2	3BUB-3B180A-2/3K1M-3ZA	946825C7	910613	185	S308436
	81	478	17.2	3BUB-3B260A-2/3K2M-3ZA	946827C5	910613	185	S308436
								
	59	665	16.3	3BB-3B180A-3K1M-3VK1M	946821D9	910613	185	S308439
	59	665	16.3	3BB-3B260A-3K2M-3VK2M	946823D7	910613	185	S308439
								
	59	473	18.2	3BUB-3B180A-3K1M-3VK1M	946829D1	910613	185	S308439
	59	473	18.2	3BUB-3B260A-3K2M-3VK2M	946831D7	910613	185	S308439
								
	81	719	18.9	3BB-3B180A-3K1M-3WK1M	946917D4			929065
	81	719	18.9	3BB-3B260A-3K2M-3WK2M	946921D8			929065
								
	81	527	20.9	3BUB-3B180A-3K1M-3WK1M	946919D2			929065
	81	527	20.9	3BUB-3B260A-3K2M-3WK2M	946923D6			929065

The transducer can be rotated for crowded multiple spindle arrangements (DGD 15° radial toothing). = maximum accessibility. Floating adapter not included with spindle.

2D and 3D are available to download at www.apexpowertools.com in the Customer Support section or on www.apexpowertools.eu in the download area.

DGD Fixtured Spindles

Size 4, Single Transducer (torque+angle)

120 - 630 Nm

	Torque Range	Speed	Float	Square Drive
	Nm	RPM max.		

Straight drive, single transducer

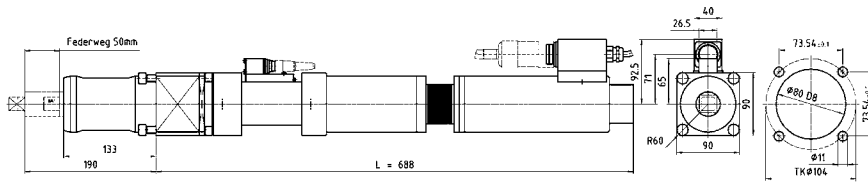

120-360	266	50	3/4"
160-460	209	50	3/4"
220-630	141	50	1"

Straight drive with reversible gears, single transducer

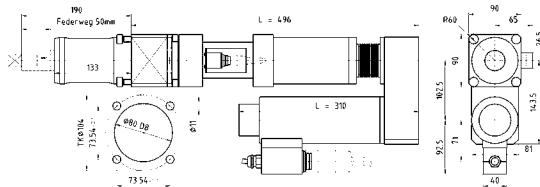

120-360	266	50	3/4"
160-460	209	50	3/4"
220-630	141	50	1"

Offset drive, single transducer

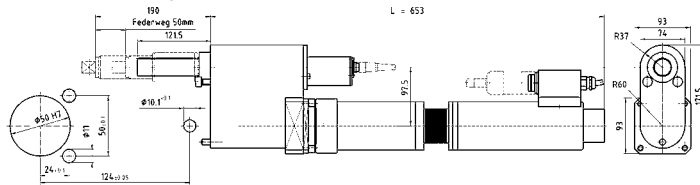

120-360	249	50	3/4"
160-460	196	50	3/4"
220-630	133	50	1"

Offset drive with reversible gears, single transducer

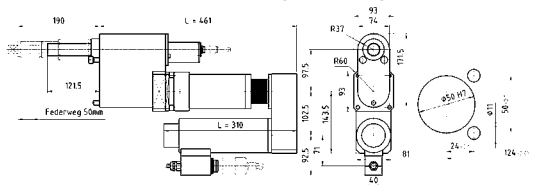

120-360	249	50	3/4"
160-460	196	50	3/4"
220-630	133	50	1"

Angle drive, single transducer

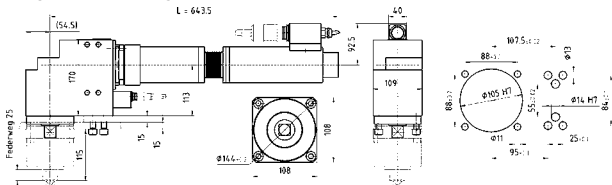

120-360	257	25	3/4"
160-460	202	25	1"
220-630	136	25	1"



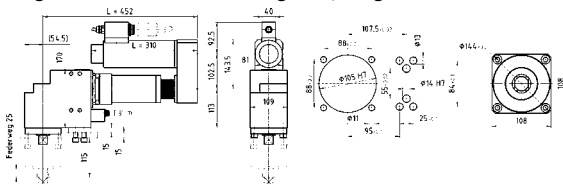











Angle drive with reversible gears, single transducer



120-360	257	25	3/4"
160-460	202	25	1"
220-630	136	25	1"

Smallest scribed circle diameter in mm

Number of spindles	Model 4		
	Attachment		Angle drive
	Straight	Offset	
2	91	76	112
3	122	88	130
4	130	108	160
5	174	130	192
6	217	153	224
7	246	180	263

	Min. Center-Center	L	Weight	Design	Order No. DGD Spindle	Floating Adapter		Floating Adapter incl. guide housing
	mm	mm	kg			Order No.	X (mm)	Order No.
 								
	91	689	20	4BB-4B360A-4K1M-4ZA	947006C6	916643	190	
	91	689	20	4BB-4B460A-4K2M-4ZA	947008C4	916643	190	
	91	689	20	4BB-4B630A-4K3M-4ZA	947010C0	916642	185	
 								
	91	497	21.5	4BUB-4B360A-4K1M-4ZA	947018C2	916643	190	
	91	497	21.5	4BUB-4B460A-4K2M-4ZA	947020C8	916643	190	
	91	497	21.5	4BUB-4B630A-4K3M-4ZA	947022C6	916642	185	
  								
	76	655	21.5	4BB-4B360A-4VK1M	947012C8	912106	190	S308440
	76	655	21.5	4BB-4B460A-4VK2M	947014C6	912106	190	S308440
	76	655	21.5	4BB-4B630A-4VK3M	947016C4	912147	186	S308474
  								
	76	463	23.0	4BUB-4B360A-4VK1M	947024C4	912106	190	S308440
	76	463	23.0	4BUB-4B460A-4VK2M	947026C2	912106	190	S308440
	76	463	23.0	4BUB-4B630A-4VK3M	947028C0	912147	186	S308474
  <p style="text-align: right; margin-right: 20px;"><i>For angle attachment</i></p>								
	112	645	26.1	4BB-4B360A-4WK1M	947036C0			929077
	112	645	26.1	4BB-4B460A-4WK2M	947038C8			929089
	112	645	26.1	4BB-4B630A-4WK3M	947040C4			929089
  <p style="text-align: right; margin-right: 20px;"><i>For angle attachment</i></p>								
	112	453	27.7	4BUB-4B360A-4WK1M	947042C2			929077
	112	453	27.7	4BUB-4B460A-4WK2M	947044C0			929089
	112	453	27.7	4BUB-4B630A-4WK3M	947046C8			929089

The transducer can be rotated for crowded multiple spindle arrangements (DGD 15° radial toothing).
 = maximum accessibility. Floating adapter not included with spindle.

2D and 3D are available to download at www.apexpowertools.com in the Customer Support section or on www.apexpowertools.eu in the download area.

DGD Fixtured Spindles

Size 4, Single Transducer (torque+angle)

400 - 2800* Nm

	Torque Range	Speed	Float	Square Drive
	Nm	RPM max.		

Straight drive, single transducer

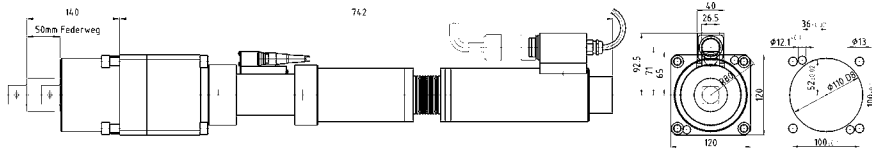

400-1250	71	50	1"
540-1600	56	50	1 1/2"

Straight drive with reversible gears, single transducer

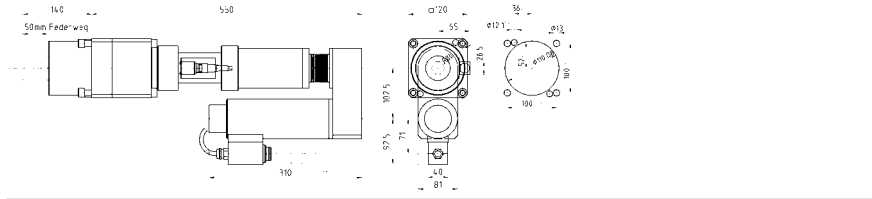

400-1250	71	50	1"
540-1600	56	50	1 1/2"

Offset drive, single transducer

Tightening Spindle BB Series special version - detailed drawings on request

750-800	110	50	1"
---------	-----	----	----

Offset drive, single transducer

Tightening Spindle BB Series special version - detailed drawings on request

400-1100	75	50	1"
----------	----	----	----

Offset drive with reversible gears, single transducer

Tightening Spindle BB Series special version - detailed drawings on request













750-800	110	50	1"
---------	-----	----	----

Offset drive with reversible gears, single transducer















Tightening Spindle BB Series special version - detailed drawings on request

400-1100	75	50	1"
----------	----	----	----

*2800 Nm spindle available on request.

	Min. Center-Center	L	Weight	Design	Order No. DGD Spindle	Floating Adapter		Floating Adapter incl. guide housing
	mm	mm	kg			Order No.	X (mm)	Order No.
								
	121	742	28	4BB-4B360A-4K1MS-4Z1250A	7355226401	S976956	140	
	121	742	28	4BB-4B460A-4K2MS-4Z1600A	7355226402	S308441	140	
								
	121	550	30	4BUB-4B360A-4K1MS-4Z1250A	7355226403	S976956	140	
	121	550	30	4BUB-4B460A-4K2MS-4Z1600A	7355226404	S308441	140	
								
	76	655	22.0	4BB-4B630A-4VK4MS	7348426116	912147	186	S308474
								
	85	792		4BB-4B630A-4K3MS-F13	7348426114			916900
								
	76	463	23.5	4BUB-4B630A-4VK4MS	7348426117	912147	186	S308474
								
	85	600		4BUB-4B630A-4K3MS-F13	7348426115			916900

The transducer can be rotated for crowded multiple spindle arrangements (DGD 15° radial toothing).
 = maximum accessibility. Floating adapter not included with spindle.
 2D and 3D are available to download at www.apexpowertools.com in the Customer Support section or on www.apexpowertools.eu in the download area.

	Min. Center-Center	L	Weight	Design	Order No. DGD Spindle	Floating Adapter		Floating Adapter incl. guide housing
	mm	mm	kg			Order No.	X (mm)	Order No.
								
	91	817	23	4BB-4B360A-2/4K1M-4ZA	947007C5	916643	190	
	91	817	23	4BB-4B460A-2/4K2M-4ZA	947009C3	916643	190	
	91	817	23	4BB-4B630A-2/4K3M-4ZA	947011C9	916642	186	
								
	91	625	24.5	4BUB-4B360A-2/4K1M-4ZA	947019C1	916643	190	
	91	625	24.5	4BUB-4B460A-2/4K2M-4ZA	947021C7	916643	190	
	91	625	24.5	4BUB-4B630A-2/4K3M-4ZA	947023C5	916642	186	
								
	76	782	24.5	4BB-4B360A-4K1M-4VK1M	947013D5	912106	190	S308440
	76	782	24.5	4BB-4B460A-4K2M-4VK2M	947015D3	912106	190	S308440
	76	782	24.5	4BB-4B630A-4K3M-4VK3M	947017D1	912147	186	S308474
								
	76	590	26.0	4BUB-4B360A-4K1M-4VK1M	947025D1	912106	190	S308440
	76	590	26.0	4BUB-4B460A-4K2M-4VK2M	947027D9	912106	190	S308440
	76	590	26.0	4BUB-4B630A-4K3M-4VK3M	947029D7	912147	186	S308474
								
	112	772	29.1	4BB-4B360A-4K1M-4WK1M	947037D7			929077
	112	772	29.1	4BB-4B460A-4K2M-4WK2M	947039D5			929089
	112	772	29.1	4BB-4B630A-4K3M-4WK3M	947041D1			929089
								
	112	580	30.7	4BUB-4B360A-4K1M-4WK1M	947043D9			929077
	112	580	30.7	4BUB-4B460A-4K2M-4WK2M	947045D7			929089
	112	580	30.7	4BUB-4B630A-4K3M-4WK3M	947047D5			929089

The transducer can be rotated for crowded multiple spindle arrangements (DGD 15° radial toothing).
= maximum accessibility. Floating adapter not included with spindle.

2D and 3D are available to download at www.apexpowertools.com in the Customer Support section or on www.apexpowertools.eu in the download area.

DGD Fixtured Spindles

Size 4, Twin Transducer (redundant) - (2x torque + 2x angle)

400 - 2800* Nm

	Torque Range	Speed	Float	Square Drive
		RPM		
	Nm	max.	mm	inch

Straight attachment, twin transducer (redundant)

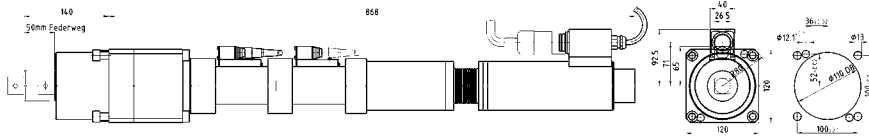

400-1250	71	50	1"
540-1600	56	50	1 1/2"

Straight attachment with reversible gears, twin transducer (redundant)

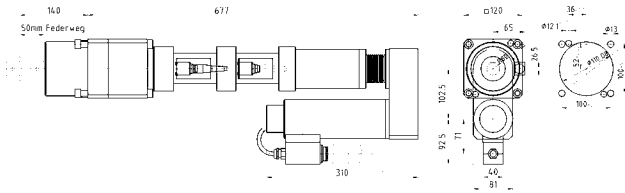

400-1250	71	50	1"
540-1600	56	50	1 1/2"

Offset attachment, twin transducer (redundant)

Tightening Spindle BB Series special version - detailed drawings on request

750-800	110	70	1"
---------	-----	----	----

Offset attachment, twin transducer (redundant)

Tightening Spindle BB Series special version - detailed drawings on request

400-1100	75	50	1"
----------	----	----	----

Offset attachment with reversible gears, twin transducer (redundant)

Tightening Spindle BB Series special version - detailed drawings on request













750-800	110	70	1"
---------	-----	----	----

Offset attachment with reversible gears, twin transducer (redundant)

Tightening Spindle BB Series special version - detailed drawings on request

400-1100	75	50	1"
----------	----	----	----

*2800 Nm spindle available on request.

	Min. Center-Center	L	Weight	Design	Order No. DGD Spindle	Floating Adapter		Floating Adapter incl. guide housing
	mm	mm	kg			Order No.	X (mm)	Order No.
								
	121	868		4BB-4B360A-2/4K1MS-4Z1250A	7355226405	S976956	140	
	121	868		4BB-4B460A-2/4K2MS-4Z1600A	7355226406	S308441	140	
								
	121	677		4BUB-4B360A-2/4K1MS-4Z1250A	7355226407	S976956	140	
	121	677		4BUB-4B460A-2/4K2MS-4Z1600A	7355226408	S308441	140	
								
	76	782		4BB-4B630A-4K3MS-4VK4MS	7348426118	912147	186	S308474
								
	85	919		4BB-4B630A-2/4K3MS-F13	7348426119			916900
								
	76	590		4BUB-4B630A-4K3M-4VK4MS	7348426120	912147		S308474
								
	85	727		4BUB-4B630A-2/4K3MS-F13	7348426121			916900

The transducer can be rotated for crowded multiple spindle arrangements (DGD 15° radial toothing).
= maximum accessibility. Floating adapter not included with spindle.

2D and 3D are available to download at www.apexpowertools.com in the Customer Support section or on www.apexpowertools.eu in the download area.

Fixtured Nutrunners – Transducer Control

Right Angle, Offset & Inline Spindle Tools

Cleco®

EMT Offset Fixtured Spindles Series

Torque Range
54 - 1073 Nm
40 - 792 Ft. Lbs.

Bolt Size
M10 - M27
7/16" - 1 1/4"



EMT Offset Floating Spindles			Torque Range		Max Speed	Float		Output drive size	Min center dist		Weight		Length	
Part No.	Motor Size	Model No	ft. lbs	Nm	RPM	in.	mm.		in	mm	lbs	kg.	in.	mm
571413	3	EMT600-2-OS600-1"-APM	576	781	102	2	50.8	1"	2.44	62	45	20.4	30.38	771.6
571503	4	EMT800-2-OS800-1"-APM	792	1073	102	2	50.8	1"	2.81	71.5	90	40.8	34.56	877.8

*EMT Fixtured Offset tools may be configured to meet your requirements. Contact Apex Tool Group for your configuration.

Standard Equipment: Air LB Connector.

Optional Connectors: Contact your nearest ATG Sales & Service Center if a motor is required with a VEAM or PTR connector.

Cleco®

EMT Inline Fixtured Spindles Series

Torque Range
54 - 1485 Nm
40 - 1095 Ft. Lbs.

Bolt Size
M10 - M30
7/16" - 1 3/8"



EMT Inline Floating Spindle			Torque Range		Max Speed	Float		Output drive size	Min center dist		Weight		Length	
Part No.	Motor Size	Model No.	ft. lbs	Nm	RPM	in.	mm.		in	mm	lbs	kg.	in.	mm
571404	3	EMT600-2R6-1"-APM	576	781	102	2	50.8	1"	3.56	90.5	35	15.9	24.25	616
571500	4	EMT800-2R6-1"-APM	792	1073	102	2	50.8	1"	3.75	95.3	50	22.6	28.44	722.4
571002	4	EMT1200-2R8-1"-APM	1095	1485	74	2	50.8	1"	4.69	119	60	27.2	32.91	835.9

*EMT200, EMT400 - Optional length spindle drivers available (R8,R10,R12)

*EMT600, EMT800 - Optional length spindle drivers available (R8,R10,R12,R16)

*EMT200 - Output drive size (Sq. Drive) available in 1/2", 5/8"

*EMT400, EMT600 - Output drive size (Sq. Drive) available in 3/4", 1"

*EMT Fixtured tools may be configured to meet your requirements.

Contact Apex Tool Group for your configuration.

Standard Equipment: Air LB Connector

Optional Connectors: Contact your nearest ATG Sales & Service Center if a motor is required with a VEAM or PTR connector.

Cleco® 18ESE, 48ESE & 67ES Inline Fixtured Spindle Series



Torque Range
2 - 2060 Nm
1.5 - 1520 Ft. Lbs.

Bolt Size
M5 - M36
#10 - 1 1/2"

Cleco Inline Floating Spindle Model Number	Torque Range		Max. Speed RPM	Float		Output Drive Size	Minimum Center to Center		Weight*		Length	
	ft. lbs.	Nm		in.	mm		in.	mm	lbs.	kg	in.	mm
18ESE06ZA	1.5-4.4	2-6	4000	.98	25	1/4	1.81	46	3.0	1.4	15.5	394
18ESE12ZA	2.2-8.9	3-12	1820	.98	25	1/4	1.81	46	3.2	1.5	16.0	406
18ESE17ZA	3.0-12.5	4-17	1290	.98	25	1/4	1.81	46	3.2	1.5	16.0	406
48ESE12ZA	2.2-8.9	3-12	4000	.98	25	1/4	1.81	46	3.4	1.5	16.7	425
48ESE271ZB	4.4-19.9	6-27	1820	1.97	50	3/8	1.81	46	5.8	2.6	22.0	559
48ESE361ZB	5.9-28.0	8-38	1290	1.97	50	3/8	1.81	46	5.8	2.6	22.0	559
48ESE602ZB	8.8-42.0	12-57	855	1.97	50	1/2	2.20	56	8.4	3.8	24.4	620
48ESE702ZB	10.3-50.2	14-68	570	1.97	50	1/2	2.20	56	8.4	3.8	24.4	620
48ESE802ZB	12.5-60.5	17-82	450	1.97	50	1/2	2.44	62	9.6	4.4	26.7	678
48ESE1152ZB	18.4-84.8	25-115	320	1.97	50	1/2	2.44	62	9.6	4.4	26.7	678
48ESE1502ZB	22.1-110.6	30-150	245	1.97	50	1/2	2.44	62	9.6	4.4	26.7	678
48ESE1653ZB	24.3-121.7	33-165	220	1.97	50	3/4	3.15	80	14.6	6.6	28.6	726
48ESE2503ZB	36.1-182.1	49-247	145	1.97	50	3/4	3.15	80	14.6	6.6	28.6	726
67ES65BZ4	10-47	13-64	535	.69	17.6	1/2	1.31	33	10.8	4.9	21.0	533
67ES105BZ4	15-77	21-104	330	.69	17.6	1/2	1.31	33	10.8	4.9	21.0	533
67ES135BZ4	20-100	27-135	245	.69	17.6	1/2	1.31	33	10.8	4.9	21.0	533
67ES190Z6	28-140	38-190	165	.75	19	3/4	1.31	33	15.6	7.1	22.0	559
67ES285Z6	42-210	57-285	115	.75	19	3/4	1.31	33	15.6	7.1	22.0	559
67ES385Z6	57-285	77-386	83	.75	19	3/4	1.31	33	15.6	7.1	22.0	559
67ES475Z6	70-350	95-475	67	.75	19	3/4	1.31	33	16.0	7.3	22.4	569
67ES610Z6	90-450	122-610	50	.75	19	3/4	1.31	33	16.0	7.3	22.4	569
67ES850Z8	125-625	170-848	33	1.0	25	1	1.50	38	20.0	9.1	23.8	605
67ES1050Z8	155-775	210-1050	27	1.0	25	1	1.50	38	20.0	9.1	23.8	605
67ES1670Z8	246-1230	334-1668	17	1.0	25	1	1.50	38	20.0	9.1	23.8	605
67ES2060Z8	304-1520	412-2060	14	1.0	25	1	1.50	38	20.0	9.1	23.8	605

*Weights are without tool cable and mounting plate.
General: All tools must be used with an approved ATG cable and controller.
Standard Equipment: 18/48 series tools; Air-LB Connector; Mounting plate.
 Tools with Matrix connector available upon request.
 67 tools; Matrix Connector; Mounting plate

Extra Equipment: 18/48 tools; Std. tool cable 301866-XX, RA swivel cable 301903-XX, Inline swivel cable 301904-XX, Extension cable 301877-XX.
 67 tools; Std. tool cable 542778-XX, RA swivel cable 544055-XX, Inline swivel cable 544056-XX, Extension cable 542779-XX.
Additional Accessories: See pages 121-129 for additional accessories.



Cleco® Right 18EAE, 48EAE & 67EA Angle Fixtured Spindle

Torque Range
5.1 - 255 Nm
3.7 - 188.1 Ft. Lbs.

Bolt Size
M7 - M18
1/4" - 3/4"

Cleco Angle Floating Spindle Model Number	Torque Range		Max. Speed RPM	Float		Output Drive Size	Minimum Center to Center		Weight*		Length	
	ft. lbs.	Nm		in.	mm		in.	mm	lbs.	kg	in.	mm
18EAE16S131	3.7-12.5	5.1-17	1225	.98	25	3/8	1.10	28	4.4	2.0	16.0	406
18EAE23S131	5.3-17.7	7.2-24	860	.98	25	3/8	1.10	28	4.4	2.0	16.0	406
18EAE30S131	4.4-22.8	6.0-31	655	.98	25	3/8	1.10	28	4.4	2.0	16.0	406
48EAE37S231	5.9-28.0	8.0-38	1225	.74	19	3/8	1.33	34	5.2	2.4	18.6	474
48EAE52S231	8.1-39.8	11-54	860	.74	19	3/8	1.33	34	5.2	2.4	18.6	474
48EAE53S341	8.1-39.8	11-54	850	.74	19	1/2	1.73	44	5.9	2.7	20.0	509
48EAE74S341	11.0-56.8	15-77	600	.74	19	1/2	1.73	44	5.9	2.7	20.0	509
48EAE95S341	14.7-72.2	20-98	460	.74	19	1/2	1.73	44	5.9	2.7	20.0	509
48EAE110S341	16.9-81.1	23-110	400	.74	19	1/2	1.73	44	7.2	3.3	20.5	521
48EAE135S461	20.6-101.7	28-138	270	.74	19	3/4	2.12	54	8.8	4.0	20.5	522
48EAE230S461	34.6-172.5	47-234	150	.74	19	3/4	2.12	54	10.3	4.7	22.1	563
67EA150S461	22.1-110.6	30-150	210	.74	19	3/4	2.04	52	13.0	5.9	25.7	655
67EA185S461	27.3-136.3	37-185	170	.74	19	3/4	2.04	52	13.0	5.9	25.7	655
67EA210S461	31.0-154.8	42-210	155	.74	19	3/4	2.04	52	13.0	5.9	25.7	655
67EA235S461	33.9-169.6	46-230	135	.74	19	3/4	2.04	52	13.0	5.9	25.7	655
67EA255S461	40.6-188.1	55-255	115	.74	19	3/4	2.04	52	13.0	5.9	25.7	655

*Weights are without tool cable and mounting plate.
Note: All 67 series tools require an isolation transformer (544185PT) for use with Cleco Global Controller.

General: All tools must be used with an approved ATG cable and controller.
Standard Equipment: 18/48 series tools; Air-LB Connector; Mounting plate.
 Tools with Matrix connector available upon request.
 67 series tools; Matrix Connector; Mounting plate

Extra Equipment: 18/48 tools; Std. tool cable 301866-XX, RA swivel cable 301903-XX, Inline swivel cable 301904-XX, Extension cable 301877-XX.
 67 tools; Std. tool cable 542778-XX, RA swivel cable 544055-XX, Inline swivel cable 544056-XX, Extension cable 542779-XX.
Additional Accessories: See pages 121-129 for additional accessories.

Fixtured Electric Nutrunners

Accessories

Connection & Extension Cables For Conventional Spindles

Field Quality

For fixed cables, e.g. in stationary machine components

HighFlex Quality

For movable cables with demanding requirements

SuperHighFlex Quality

For movable cables and extreme requirements, e.g. robot applications

Type C

Extremely flexible, direct connection between the nutsetter and nutsetter control unit in HighFlex quality

Type B

Fixed cable in field quality from intermediate connection point to the nutsetter control unit

Type A1

Extremely flexible connection in HighFlex quality between nutsetter and intermediate connection point

Type A2

Alternative to 960430-xxx for robot applications; extra-flexible connection between nutsetter and intermediate connection point in SuperHighFlex quality

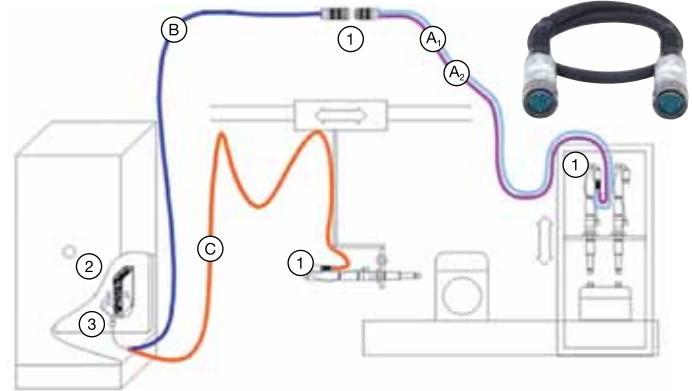

① Push-Pull connector

② Connectors

③ S961062 shield terminals are required for each TMx channel

Ⓒ Field Cable Highflex quality
960432-XXX, L = 4-20 m

Ⓓ Cable Field quality
960431-XXX, L = 6-50 m

Ⓐ₁ Extension cable High-Flex
quality 960430-XXX, L = 2-20 m
OR

Ⓐ₂ Extension cable Super-High-Flex
quality 960433-XXX, L = 2-20 m

Cable Length	Type C	Type B	Type A ₁	Type A ₂	Cable for Second Transducer ¹	Cable for Second Transducer ²
2m	960432-020	960431-020	960430-020	960433-020	960960-020 ¹	960961-020 ²
4m	960432-040	960431-040	960430-040	960433-040	960960-040 ¹	960961-040 ²
6m	960432-060	960431-060	960430-060	960433-060	960960-060 ¹	960961-060 ²
10 m	960432-100	960431-100	960430-100	960433-100	960960-100 ¹	960961-100 ²
20 m	960432-200	960431-200	960430-200	960433-200	960960-200 ¹	960961-200 ²
30 m	960432-300	960431-300	960430-300	960433-300	960960-300 ¹	960961-300 ²
40 m	960432-400	960431-400	960430-400	960433-400	960960-400 ¹	960961-400 ²
50 m	960432-500	960431-500	960430-500	960433-500	960960-500 ¹	960961-500 ²

PE cable for fastener plate 960408-xxx. Available in any length, preferred in 2 m grid

The order number extension indicates the length of the cable in decimetres.

¹960960-XXX must be used parallel to cable type B and C.

²960961-XXX must be used parallel to cable type A1 and A2

Accessory Cables

Part No.	Accessory Cable Description
543446-7	Ethernet Cable Crossover - 2M
543445-7	Ethernet Cable Patch - 2M
544196-005	System Bus Cable - 0.5M
544196-020	System Bus Cable - 2M
544196-050	System Bus Cable - 5M
544196-200	System Bus Cable - 20M
544196-500	System Bus Cable - 50M
544197	System Bus Terminator
935170	Serial Cable IrDA - 1M
543490-10	Serial Cable Null Modem - 3M

DGD Floating Adapter

Model No.	Motor Size	Maximum Torque		X		Output Drive Size	Drive
		ft. lbs.	Nm	in.	mm		
922325PT	1	44.25	60	7.08	180	3/8	1ZB 1VK
910609	2	118.00	160	7.08	180	1/2	2ZB 2VK
935552	2	147.51	200	7.08	180	3/4	2ZB 2VK
910613	3	383.63	520	7.28	185	3/4	3ZB 3VK
912106	4	383.63	520	7.48	190	3/4	4VK
912147	4	553.17	750	7.32	186	1	4VK
S976956	4	553.17	750	5.31	140	1	4ZA
S308441	4	1180.09	1600	5.31	140	1 1/2	4ZA
916642	4	464.66	630	7.28	185	1	4ZA
916643	4	383.63	520	7.48	190	3/4	4ZA

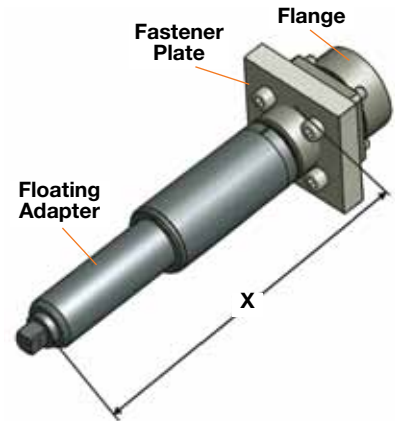

DGD Floating Adapter Including Flange Housing

Model No.	Motor Size	Maximum Torque		X		Output Drive Size	Drive
		ft. lbs.	Nm	in.	mm		
S308434	1	44.25	60	6.61	168	3/8	1ZB
S308435	2	118.00	160	6.77	172	1/2	2ZB
S308450	2	147.51	200	6.77	172	3/4	2ZB
S308436	3	383.63	520	6.92	176	3/4	3ZB
S308437	1	44.25	60	6.61	168	3/4	1VK
S308438	2	81.13	110	6.55	166.5	1	2VK
S308475	2	147.51	200	6.55	166.5	1	2VK
S308439	3	221.26	300	6.73	171	1 1/2	3VK
S308440	4	383.63	520	6.88	175	3/4	4VK
S308474	4	486.79	660	6.73	171	1	4VK

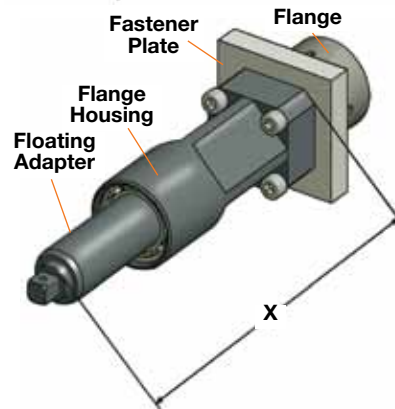

DGD Floating Adapter Including Flange Housing for Right Angle Drive

Model No.	Motor Size	Maximum Torque		X		Output Drive Size
		ft. lbs.	Nm	in.	mm	
929041	1	44.25	60	2.95	75	3/8
929053	2	125.38	170	3.54	90	1/2
929061	2	147.51	200	4.52	115	3/4
929065	3	221.26	300	4.13	105	3/4
929077	4	383.63	520	4.52	115	3/4
929089	4	486.79	660	4.52	115	1

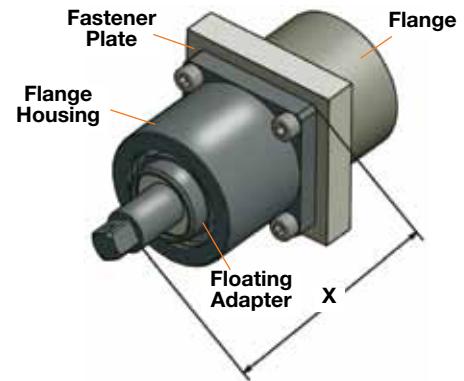

Mounting Brackets for EMT Series Tools

EMT 80 Series

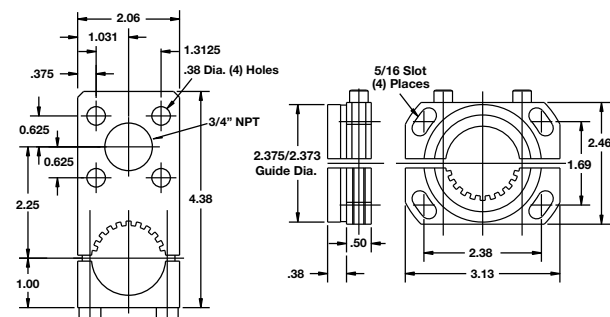

Torque Reaction Bracket
#201012 (Standard)

Torque Reaction Bracket
#201039 (Optional)

EMT 200 & 400 Series

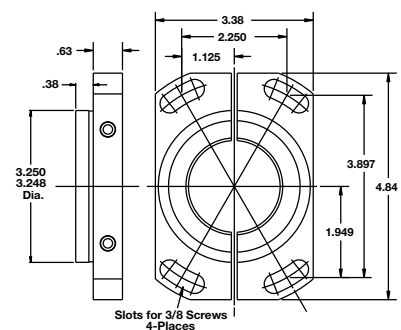

Torque Reaction Bracket
#201034 (Standard)

Torque Reaction Bracket
#201510 (Optional)

Cleco mPro400GC Global Controller

Master, Primary & Secondary



mPro400GC Global Controller

- Graphics interface
- Fully programmable
- Local storage of 10,000 cycles
- LAN capable
- Fieldbus options available

Master/Primary Unit

Secondary Unit



MPRO400GC-M



MPRO400GC-P



MPRO400GC-S

mPro400GC-SG Global Controller

The mPro400GC-SG controller provides the same capabilities and functions as the mPro400GC-M controller with the added convenience of panel mount installation.



Model	Description	Tool Compatibility	Weight		Width		Height		Depth	
			lbs.	kg	in.	mm	in.	mm	in.	mm
MPRO400GC-P	Primary	Cleco 18-48 Series, LiveWire, Intelligent Spindle*	30.7	13.9	10.3	261.62	14.9	378.46	12.9	327.66
MPRO400GC-S	Secondary	Cleco 18-48 Series	28.1	12.7	10.3	261.62	14.9	378.46	12.9	327.66
MPRO400GC-M	Master	LiveWire, Intelligent Spindle*	23.3	10.6	10.3	261.62	14.9	378.46	12.9	327.66
MPRO400GC-SG	Panel Mount	LiveWire, Intelligent Spindle, 1,2,3,4								

*Requires quote to accommodate hardware configurations.

Note: 17/47/67 and Matrix versions of the 18/48 series tools require Isolation Transformer 544185PT for use with Primary/Secondary controllers.

Panel Mount can be used in different cabinet solutions.



Cleco®

Torque Control mPro400GC-E & mPro400GC-I Global Controllers

- Single channel
- Economical
- Remote programming
- Local storage of 5,000 cycles
- LAN capable
- Input Voltage: 115/230VAC
- Connections:
 - 1x Serial
 - 1x TM-COM
 - 1x Ethernet
- Inputs/Outputs:
 - 8x 24V Inputs,
 - 8x 24V Outputs



MPro400GC-E & MPro400GC-I

All 67 Series Tools require an isolation transformer (544185PT) for use with Cleco Global Controller.



Model	Description	Tool Compatibility	Weight		Width		Height		Depth	
			lbs.	kg	in.	mm	in.	mm	in.	mm
MPro400GC-E	Torque Control	Cleco 18-48 E_E Series*	32.8	14.8	10.3	261.62	14.9	378.46	12.9	327.66
MPro400GC-I	Current Control	Cleco 18-48 C_E Series**	32.8	14.8	10.3	261.62	14.9	378.46	12.9	327.66

*Note: 17/47/67 and Matrix versions of the 18/48 series tools require Isolation Transformer 544185PT for use with GC-E model.

**Note: 48 series tools require 230 VAC.

Standard Equipment: TM-COM Remote Programming Software, Null Modem Serial Cable, and crossover Ethernet cable.

DGD mPro400SG Global Controllers

DGD Spindle Controllers



mPro400SG Global Controllers

- Graphics interface
- Fully programmable
- Local storage of 10,000 cycles
- LAN capable
- Fieldbus options available

The mPro400SG can be substituted for a remotely mounted mPro400GC-M.



S112849-SG – DGD size 1 & 2 spindles



S112850-SG – DGD size 1 & 2 spindles



S112870-SG – DGD size 3 & 4 spindles



The Mid-Six controller is a wall mounted design capable of handling up to six conventional spindles. It is shown with the optional surface mount mPRO400 controller. Contact the factory for a quotation.

Model	Order No.	Tool Compatibility	Width		Height		Depth	
			in.	mm	in.	mm	in.	mm
MPRO400SG	S112849-SG	DGD Spindles, size 1 & 2, 1.2/01-channel	18.9	480.0	14.2	360.0	11.0	280.0
MPRO400SG	S112850-SG	DGD Spindles, size 1 & 2, 1.2/02-channel	30.0	763.0	14.9	380.0	13.8	350.0
MPRO400SG	S112870-SG	DGD Spindles, size 3 & 4, 3/4 01-channel	30.0	763.0	14.9	380.0	13.8	350.0
MPRO400SG	S112871-SG	DGD Spindles, size 3 & 4, 3/4 01-channel	30.0	763.0	14.9	380.0	13.8	350.0



mPro400SG Global Controller Cabinets

The size of the cabinet depends on the number and size of the DGD spindles. Control cabinet for spindle sizes 1/2, 1-32 channels.



Order No.	Description	Width		Height		Depth	
		in.	mm	in.	mm	in.	mm
S112860-01-SG	1 Channel	23.6	600	78.7	2000	19.6	500
S112860-02-SG	2 Channel	23.6	600	78.7	2000	19.6	500
S112860-03-SG	3 Channel	23.6	600	78.7	2000	19.6	500
S112860-04-SG	4 Channel	23.6	600	78.7	2000	19.6	500
S112860-05-SG	5 Channel	23.6	600	78.7	2000	19.6	500
S112860-06-SG	6 Channel	23.6	600	78.7	2000	19.6	500
S112860-07-SG	7 Channel	23.6	600	78.7	2000	19.6	500
S112860-08-SG	8 Channel	23.6	600	78.7	2000	19.6	500
S112860-09-SG	9 Channel	47.2	1200	78.7	2000	19.6	500
S112860-10-SG	10 Channel	47.2	1200	78.7	2000	19.6	500
S112860-11-SG	11 Channel	47.2	1200	78.7	2000	19.6	500
S112860-12-SG	12 Channel	47.2	1200	78.7	2000	19.6	500
S112860-13-SG	13 Channel	47.2	1200	78.7	2000	19.6	500
S112860-14-SG	14 Channel	47.2	1200	78.7	2000	19.6	500
S112860-15-SG	15 Channel	47.2	1200	78.7	2000	19.6	500
S112860-16-SG	16 Channel	47.2	1200	78.7	2000	19.6	500
S112860-17-SG	17 Channel	70.8	1800	78.7	2000	19.6	500
S112860-18-SG	18 Channel	70.8	1800	78.7	2000	19.6	500
S112860-19-SG	19 Channel	70.8	1800	78.7	2000	19.6	500
S112860-20-SG	20 Channel	70.8	1800	78.7	2000	19.6	500
S112860-21-SG	21 Channel	70.8	1800	78.7	2000	19.6	500
S112860-22-SG	22 Channel	70.8	1800	78.7	2000	19.6	500
S112860-23-SG	23 Channel	70.8	1800	78.7	2000	19.6	500
S112860-24-SG	24 Channel	70.8	1800	78.7	2000	19.6	500
S112860-25-SG	25 Channel	70.8	1800	78.7	2000	19.6	500
S112860-26-SG	26 Channel	70.8	1800	78.7	2000	19.6	500
S112860-27-SG	27 Channel	70.8	1800	78.7	2000	19.6	500
S112860-28-SG	28 Channel	70.8	1800	78.7	2000	19.6	500
S112860-29-SG	29 Channel	94.4	2400	78.7	2000	19.6	500
S112860-30-SG	30 Channel	94.4	2400	78.7	2000	19.6	500
S112860-31-SG	31 Channel	94.4	2400	78.7	2000	19.6	500
S112860-32-SG	32 Channel	94.4	2400	78.7	2000	19.6	500



mPro400SG Global Controller Cabinets

The size of the cabinet depends on the number and size of the DGD spindles. Control cabinet for spindle sizes 3/4, 1-32 channels.

Order No.	Description	Width		Height		Depth	
		in.	mm	in.	mm	in.	mm
S112861-01-SG	1 Channel	23.6	600	78.7	2000	19.6	500
S112861-02-SG	2 Channel	23.6	600	78.7	2000	19.6	500
S112861-03-SG	3 Channel	23.6	600	78.7	2000	19.6	500
S112861-04-SG	4 Channel	23.6	600	78.7	2000	19.6	500
S112861-05-SG	5 Channel	23.6	600	78.7	2000	19.6	500
S112861-06-SG	6 Channel	23.6	600	78.7	2000	19.6	500
S112861-07-SG	7 Channel	23.6	600	78.7	2000	19.6	500
S112861-08-SG	8 Channel	23.6	600	78.7	2000	19.6	500
S112861-09-SG	9 Channel	47.2	1200	78.7	2000	19.6	500
S112861-10-SG	10 Channel	47.2	1200	78.7	2000	19.6	500
S112861-11-SG	11 Channel	47.2	1200	78.7	2000	19.6	500
S112861-12-SG	12 Channel	47.2	1200	78.7	2000	19.6	500
S112861-13-SG	13 Channel	47.2	1200	78.7	2000	19.6	500
S112861-14-SG	14 Channel	47.2	1200	78.7	2000	19.6	500
S112861-15-SG	15 Channel	47.2	1200	78.7	2000	19.6	500
S112861-16-SG	16 Channel	47.2	1200	78.7	2000	19.6	500
S112861-17-SG	17 Channel	70.8	1800	78.7	2000	19.6	500
S112861-18-SG	18 Channel	70.8	1800	78.7	2000	19.6	500
S112861-19-SG	19 Channel	70.8	1800	78.7	2000	19.6	500
S112861-20-SG	20 Channel	70.8	1800	78.7	2000	19.6	500
S112861-21-SG	21 Channel	70.8	1800	78.7	2000	19.6	500
S112861-22-SG	22 Channel	70.8	1800	78.7	2000	19.6	500
S112861-23-SG	23 Channel	70.8	1800	78.7	2000	19.6	500
S112861-24-SG	24 Channel	70.8	1800	78.7	2000	19.6	500
S112861-25-SG	25 Channel	70.8	1800	78.7	2000	19.6	500
S112861-26-SG	26 Channel	70.8	1800	78.7	2000	19.6	500
S112861-27-SG	27 Channel	70.8	1800	78.7	2000	19.6	500
S112861-28-SG	28 Channel	70.8	1800	78.7	2000	19.6	500
S112861-29-SG	29 Channel	94.4	2400	78.7	2000	19.6	500
S112861-30-SG	30 Channel	94.4	2400	78.7	2000	19.6	500
S112861-31-SG	31 Channel	94.4	2400	78.7	2000	19.6	500
S112861-32-SG	32 Channel	94.4	2400	78.7	2000	19.6	500



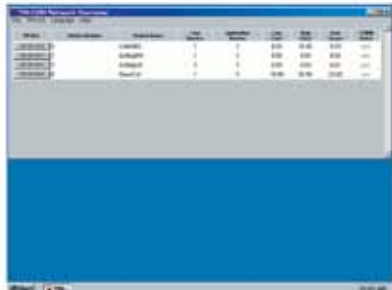

TM-COM Network overview screen lists all mPro400GC-E and mPro400GC-I controllers connected to the network.



mProRemote for mPro400GC-M and mPro400GC-P controllers.



All menus in all controllers are accessible from the Navigator screen.

Cleco®

Remote Programming Software

Cleco's remote programming software delivers ultimate control to the user, empowering them to control the production process remotely through programming that is easy to use and intuitive. Anything that can be programmed locally on the controller can also be performed from a remote location using the exact same screens.

Using this software to monitor, modify, and/or manage the production line will increase your efficiency and productivity. Centralized management of the tightening process assures quality products.

TM-COM (for GC-E/GC-I controllers) can communicate using either a RS232 or TCP/IP connection. mProRemote (for GC-M/GC-P controllers) utilizes a TCP/IP connection only.



Software

Part Number	Description
mProRemote	Provided with each mPro400GC-M & mPro400GC-P
TM-COM	Provided with each mPro400GC-E & mPro400GC-I

mProRemote & TM-COM Minimum System Requirements

- Operating System:** Windows 2000, NT or XP
- Processor:** Pentium
- Memory:** 256MB
- Free Disk Space:** 10MB per controller



System Component Connectivity

This diagram is intended to show how various components connect in a system, not necessarily the exact components required to create a particular system.

*These items do not apply to mPro400GC-E and mPro400GC-I

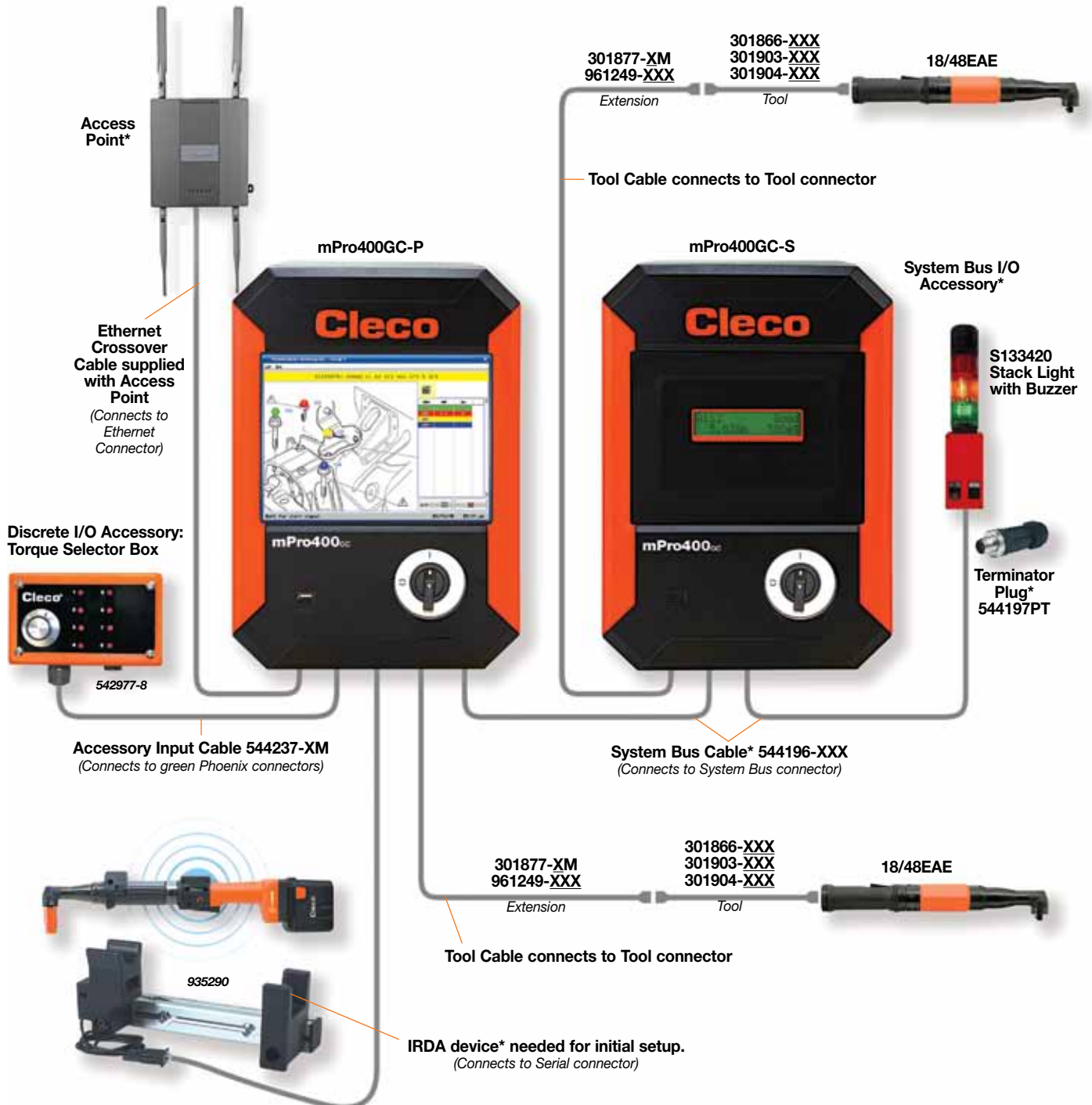



mPro400GC-IT Isolation Transformer

The purpose of the Isolation Transformer is to allow use of legacy Matrix connector tools (17/47, 18/48, and 67 Series) with the Global Controller and maintain safety and CE standards.



Air-Lb Connector



Matrix Connector

- 115/230 VAC Operation Selectable (Not auto sensing, switch selectable). Factory default setting is 230 VAC.
- All connection cables included except Tool Cables. See below.

544185PT Isolation Transformer Applications

Controller	Tool Used					
	17/47E_XX (Matrix)	18/48E_XX (Matrix)	18/48E_EXX (Air-Lb)	67E_XX (Matrix)	17/18C_EXX (Air-Lb)	Fixtured Spindles (DGD/EMT)
TME/TMEM	No	No	Adapter Cable Required	No	NA	NA
mPro400GC-P	Yes	Yes	No	Yes	NA	NA
mPro400GC-S	Yes	Yes	No	Yes	NA	NA
mPro400GC-M	NA	NA	NA	NA	NA	NA
mPro400GC-E	Yes	Yes	No	Yes	NA	NA
mPro400GC-I	NA	NA	NA	NA	No	NA

Matrix Tool Cables

For use with Matrix connector style tools used with isolation transformer above.

Model Number		Swivel		Length	
Tool	Extension	Right Angle	Inline	Feet	Meters
542778-1M*	542779-1M	544055-1M*	544056-1M*	3	1
542778-2M*	542779-2M	544055-2M*	544056-2M*	6	2
542778-3M	542779-3M	544055-3M	544056-3M	9	3
542778-6M	542779-6M	544055-6M	544056-6M	19.5	6
542778-8M	542779-8M	544055-8M	544056-8M	26	8
542778-10M	542779-10M	544055-10M	544056-10M	33	10
542778-15M	542779-15M	544055-15M	544056-15M	49	15
542778-25M	542779-20M			66	20
	542779-25M			82	25
	542779-30M			96	30
	542779-40M			131	40
542778-50M	542779-50M	544055-50M	544056-50M	164	50

Maximum cable length 100M.

Overall minimum cable length 3M.

*Must be used with 542779 extension cable.



Swivel Cable

Accessories



Tool Cables

For use with Air-Lb connector style tools used with the mPro400GC-P, -S, and _I.

Tool (Std. Durability)	Tool (High Durability)	Extension	Swivel				Length	
			Right Angle (Std. Durability)	Right Angle (High Durability)	Inline (Std. Durability)	Inline (High Durability)	Feet	Meters
Non-European Union Cables								
301866-1M*	-	301877-1M	301903-1M*	-	301904-1M*	-	3	1
301866-2M*	-	301877-2M	301903-2M*	-	301904-2M*	-	6	2
301866-3M	-	301877-3M	301903-3M	-	301904-3M	-	9	3
301866-6M	-	301877-6M	301903-6M	-	301904-6M	-	19.5	6
301866-8M	-	301877-8M	301903-8M	-	301904-8M	-	26	8
301866-10M	-	301877-10M	301903-10M	-	301904-10M	-	33	10
301866-15M	-	301877-15M	301903-15M	-	301904-15M	-	49	15
-	-	301877-20M	-	-	-	-	66	20
European Union Cables								
961259-010	961250-010	961249-010	-	961252-010	-	961251-010	3	1
961259-020	961250-020	961249-020	-	961252-020	-	961251-020	6	2
961259-030	961250-030	961249-030	-	961252-030	-	961251-030	9	3
961259-040	961250-040	961249-040	-	961252-040	-	961251-040	12	4
961259-050	961250-050	961249-050	-	961252-050	-	961251-050	15	5
961259-060	961250-060	961249-060	-	961252-060	-	961251-060	19.5	6
961259-070	961250-080	961249-080	-	961252-080	-	961251-080	26	8
961259-080	961250-100	961249-100	-	961252-100	-	961251-100	33	10
961259-100	961250-120	961249-120	-	961252-120	-	961251-120	39	12
961259-110	961250-130	961249-130	-	961252-130	-	961251-130	42.6	13
961259-120	961250-140	961249-140	-	961252-140	-	961251-140	45.9	14
961259-130	961250-150	961249-150	-	961252-150	-	961251-150	49.2	15
961259-140	961250-180	961249-180	-	961252-180	-	961251-180	59	18
961259-150	961250-220	961249-200	-	961252-220	-	961251-200	65.6	20
961259-180	-	961249-220	-	-	-	961251-220	72.1	22
961259-220	-	961249-250	-	-	-	-	82.0	25

Maximum tool to controller cable length 20M. If greater than 20m tool cable lengths are required, please contact your application center for support.

Overall minimum cable length 3M.

*Must be used with 301877 extension cable.

Batteries

Part No.	Description	Weight	
		lbs.	kg
935377	26V Li-Ion	1.1	0.50
936400PT	44V Li-Ion	1.9	0.85



Battery Charger

Part No.	Description
936491PT	26V/44V charger



Vmax Power Module

Model No.	Weight		Width		Length		Depth	
	lbs.	kg	in.	mm	in.	mm	in.	mm
961350PT	6.8	3.1	9.4	240	4.7	120	5.9	150

2M power cable included.

Vmax Tethers

Part Number	
Tool	Extension
961341-***	961342-***

***Length: 030=3m, 060=6m, 080=8m, 100=10m
Note: Maximum 20M length



2.4GHz to 5.0GHz Upgrade Kit

Upgrades are available at your local ATG Application Center to upgrade the W and X series 2.4GHz tools to a 5.0GHz Y series tool.

LiveWire Communication Access Points

Part No.	Description
961390	XBEE 802.15.4 Base Station
544249PT	WLAN Dual Band 2.4/5GHz (US)
961453PT	WLAN Dual Band 2.4/5GHz (EU)

Radio Range: 30-50 meters (XBEE 30 meters max.)
IEEE 802.11a/b/g (depending on tool)
Max. Tools: 16 (Contact Regional Support Center for requirements greater than 10)



544249PT



Preventative Maintenance Diagnostics

- USB to PC interface
- Displays discharge cycles, total and per cell voltage
- Better diagnostics
- Easy to troubleshoot

Battery service interface allows cycles and cell voltages to be read via serial interface cable.

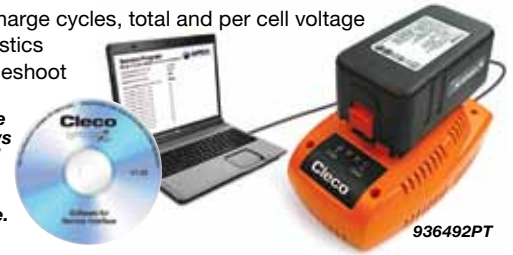

mPro400GC Program & OS Software

Part No.	Description
544163PT	CompactFlash Module Programmed

Software

Part No.	Description
TMEB-COM-V2.03	Laptop Software for LiveWire Tools

Contact Regional Application Center for web link to software.

Tool Holders

Part No.	Description
935144	Pistol tool holder w/infrared interface
935396	Pistol tool holder
935290	Angle tool holder w/infrared interface
935395	Angle tool holder
935170	Infrared interface cable
935998	70Nm RA, Crowfoot/Tubenut holder
935999	70Nm RA, Crowfoot/Tubenut holder w/infrared interface



Tool Holder Extension Cables

Part No.	Description
935154	9' (3m) extension cable
935155	19.5' (6m) extension cable
935157	33' (10m) extension cable

Pistol Dead Handle

Part No.	Description
301837	Reversible handle mount



Tool Suspension Bail

Part No.	Description
541715-2	Angle tool swivel bail



Accessories

System Bus Accessories

Part No.	Description
544197PT	System Bus Terminator
544196-005	System Bus Cable - 0.5M
544196-020	System Bus Cable - 2M
544196-050	System Bus Cable - 5M
544196-100	System Bus Cable - 10M
544196-200	System Bus Cable - 20M
544196-250	System Bus Cable - 25M
544196-500	System Bus Cable - 50M
S133437	System Bus 16 I/O Expander
S133436	System Bus 32 I/O Expander
S133410	System Bus 4-Position Socket Tray
S133411	System Bus 8-Position Socket Tray
S133406	System Bus Control Box with Buzzer
S133405	System Bus Stack Light without Buzzer
S133420	System Bus Stack Light with Buzzer



S133420
Stack Light
with Buzzer



S133410
Socket Tray



S133406
Control Box
with Buzzer

Network Accessories

Part No.	Description
543446-7	Ethernet Crossover Cable - 7ft.
543445-7	Ethernet Patch Cable - 7ft.
543445-50	Ethernet Patch Cable - 50ft.
543445-100	Ethernet Patch Cable - 100ft.
543490-10	Serial Null Modem Cable - 3M
543444-8	Ethernet Switch - 8 Port
543444-16	Ethernet Switch - 16 Port
543444-24	Ethernet Switch - 24 Port

Fieldbus Accessories

Part No.	Description
544171PT	Fieldbus Devicenet
544172PT	Fieldbus Ethernet-IP
544173PT	Fieldbus Profibus
544174PT	Fieldbus Profinet
544211PT	Fieldbus Modbus/TCIP

544172PT
Fieldbus
Ethernet-IP



544171PT
Fieldbus
Devicenet

544174PT
Fieldbus Profinet



544173PT
Fieldbus Profibus

Discrete Output Accessories

Annunciators

Part No.	Description
542976-1	Annunciator - 1 Spindle
542976-2	Annunciator - 2 Spindle
542976-3	Annunciator - 3 Spindle
542976-4	Annunciator - 4 Spindle
542976-5	Annunciator - 5 Spindle
542976-6	Annunciator - 6 Spindle



542976-1

Discrete Input Accessories

Torque Selector Switches

Part No.	Description
542977-8	Torque Selector - 8 Position
542977-16	Torque Selector - 16 Position
542977-32	Torque Selector - 32 Position
542977-64	Torque Selector - 64 Position



542977-8

Start/Stop Switches

Part No.	Description
542972	Start Box
542973	Stop Box
542974	Start/Stop Box
542975	Start/Stop/Reverse



542975

Bits & Socket Trays (Global Controller Only)

Part No.	Description
544241PT	Tray - 4 Position with 10m cable
544242PT	Tray - 8 Position with 10m cable
S970716	Replacement Inserts

Maximum socket diameter 1.125".



544241PT



S970716

Socket Only Trays

Part No.	Description
542978-4	Socket Tray - 4 Position
542978-8	Socket Tray - 8 Position

Notes: Up to 16 linked 4 position trays maximum.
Minimum socket O.D. 1". Maximum O.D. 2.25".
See below for Socket Posts and Lockout Washers



542978-4

Socket Posts

For use with 542978-4 & 542978-8 socket trays.

Part No.	Socket Post Size	Part No.	Socket Post Size
99249181	.550/.540	99249158	.687/.677
99249169	1.062/1.052	99249157	.875/.865
99249165	.590/.580	99249156	1.000/.990
99249164	.945/.935	99249148	1.125/1.115
99249163	.827/.817	99249147	.938/.928
99249162	.709/.699	99249104	.750/.740
99249161	.625/.615	99249103	.669/.659
99249160	.437/.432	99249102	.562/.552
99249159	.812/.802	99249101	.500/.490

Note: Select socket post size within tolerance of socket used.

Choose largest socket post size (diameter) that will accept the hex size of the intended socket.

Lockout Washer

For use with 542978-4 & 542978-8 socket trays.

Part Number	Note
99248150	Vacant position lockout washer

Required for unused positions on the 542978-4 & 542978-8 socket tray.

Accessory Cables

Part No.	Description
544237-1M	Accessory Input Cable - 1M
544237-5M	Accessory Input Cable - 5M
544237-10M	Accessory Input Cable - 10M
544237-15M	Accessory Input Cable - 15M
542986-1M	Accessory to Accessory Cable - 1M
542986-5M	Accessory to Accessory Cable - 5M
542986-10M	Accessory to Accessory Cable - 10M
542986-15M	Accessory to Accessory Cable - 15M
544238-1M	Accessory Output Cable - 1M
544238-5M	Accessory Output Cable - 5M
544238-10M	Accessory Output Cable - 10M
544238-15M	Accessory Output Cable - 15M

Tool & Cable Tester

Part No.	Description
961024	Tool & cable tester tool memory programming
542991	Tool & cable tester

Note: Adapter cable required for Air-Lb tools. Contact Tech Service.



Lever Extension Kits

Description	Part No.
Lever Extension Kit (non-swivel)	541757
Lever Extension Kit (swivel)	543414

Note: Models for standard tool cable (non-swivel) and swivel cable.



Suspension Bail

Description	Part No.
Tool suspension bail	1110909



Test Fixture

Part Number
536185

Medium to Hard Torque
 Belleville Washer Test Fixture is clamped in a vise and used to test tools (10 In. Lbs. – 100 Ft. Lbs., 1.13Nm – 135.6Nm). Washers can be rearranged to simulate “hard” or “soft” joints.



Joint Simulator

Joint simulators are most frequently used to certify the repeatability of nutrunners before being installed on a production line and are also an excellent means of testing nutrunners following repair.

The Joint Simulator can simulate and test the torque output of nutrunners on both hard and soft joints. Each Joint Simulator is supplied with a quantity of spring washers which are used to test tool accuracy. Torque per revolution is varied by stacking the spring washers in different combinations.

Electronic torque testing is accomplished by attaching an external rotary transducer between the tool's square drive and the socket.

- Easy access, load, set-up and maintenance.
- Heavy-duty and economical.
- Adjustable torque reaction bracket can accommodate virtually any tool.
- For use with reversible/ non-reversible tools.



Part No.	Torque Range		Width		Height		Length	
	Ft. Lbs.	Nm	in.	mm	in.	mm	in.	mm
550006	12-220	15-300	10.4	264	16	406	26.5	667

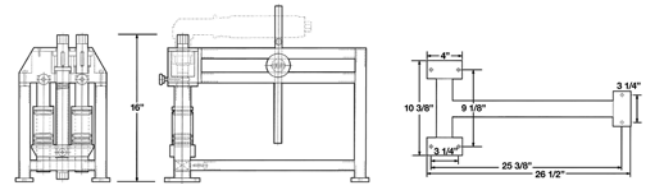

Double Joint Simulators/Test Fixture

- Separate simulator for soft and hard joint
- Inclusive mounting plate

Part Number	Description
W09164K	5 Nm hard joint/15 Nm soft joint
W08780K	10 Nm hard joint/35 Nm soft joint
W08779K	20 Nm hard joint/55 Nm soft joint



Accessories



Tool Type	Model Number	Cover	Swivel Bail	Mounting Plate	Extension
Right Angle	17/18EA...AL2	205832	541715-2	-----	-----
	17/18EA...AM3	205834	541715-2	-----	-----
	47EA...AM3/4	543070	541715-2	543235	542428
	47/48EA...AH4	543070	541715	543230	535833
	47/48EA135MH4	543071	541715	543230	535833
	47/48EA...AX6	205838	541715	543232	-----
	67EA...AL6	205838	35007004	49097101 (included with tool)	48316033
	67EA...AM6	-----	48A17006	45017152 (included with tool)	-----
Flush Socket	17/18EA...F1...	-----	541715-2	57217101 (requires 57218103 screw)	-----
	47/48EA...F2...	-----	541715-2	43287131	-----
	47/48EA...F3...	-----	541715-2	49097101(requires 49098103 locknut)	-----
	47/48EA...F4...	205838	541715	49097101(requires 49098103 locknut)	48316033
Hold-N-Drive	47/48EA ...H...over 100NM	205838	541715	49097101(requires 49098103 locknut)	48316033
	47/48EA ...H...under 100NM	205838	541715-2	49097101(requires 49098103 locknut)	48316033

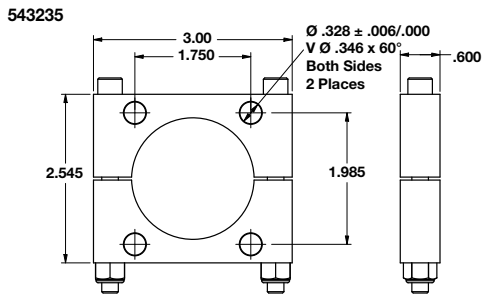
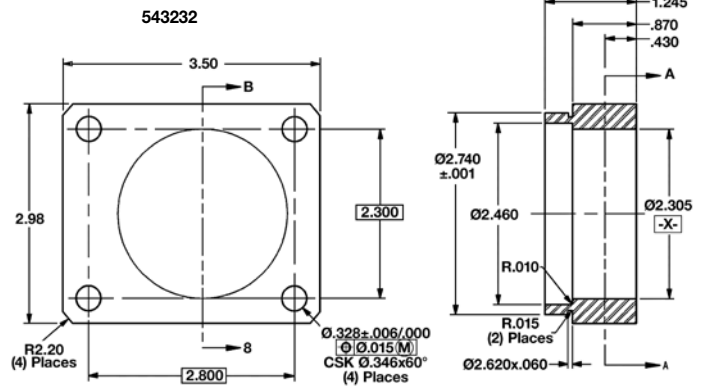
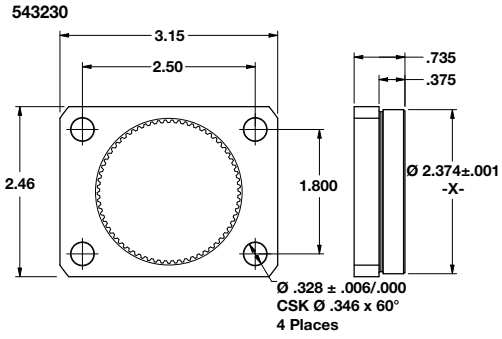

Inline Tools Mounting Plates

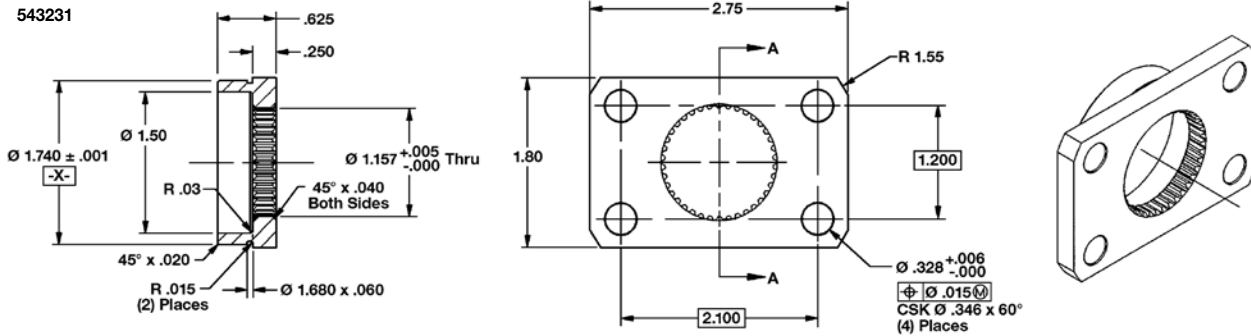

49087108

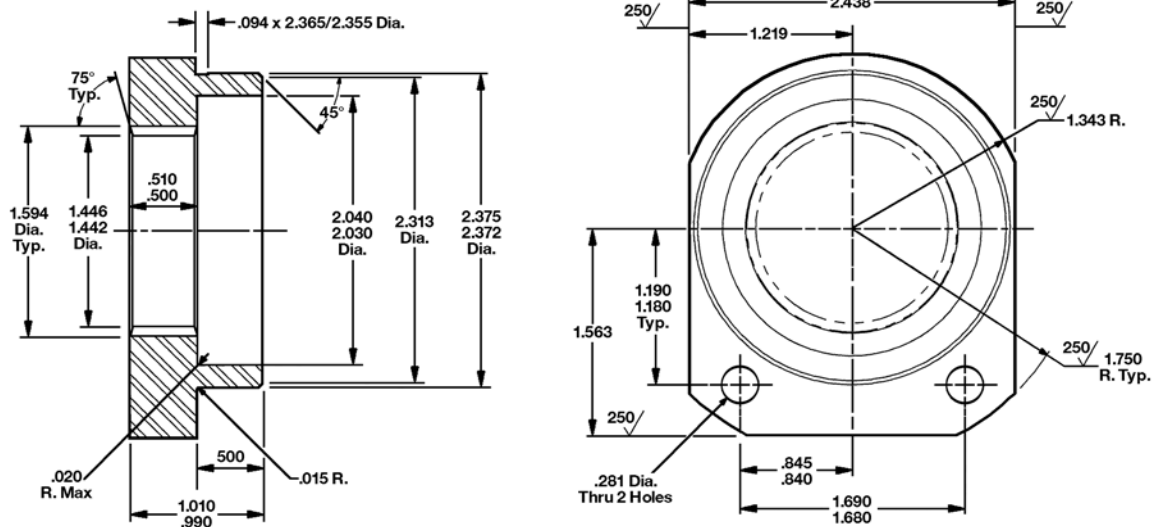

Accessories

Balance Arms



- Ball bearing construction
- Supports tools weighing up to 5 lbs. (spring models) or up to 10 lbs. (air cylinder models).
- Post, wall, or adjustable height post mounting
- Single or parallel arms

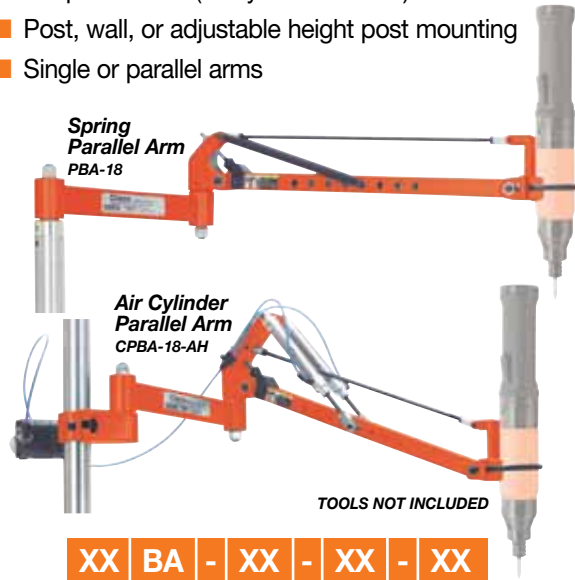

Series	Arm Extension	Mount
CS - Air cylinder, single arm	12" 24"	- Post
S - Spring, single arm	18" 30"	AH - Adjustable Height
CP - Air cylinder, parallel arm	(12" unless specified)	WM - Wall Mount
P - Spring, parallel arm		
Tool Type	Adjustable Arm Extension	
BA - Balance Arm	12" 24"	
	18" 30"	

Balance Arm Operating Envelope

MODEL	R1 MAX		R1 MIN		R2 MAX		R2 MIN		H MAX		H MIN	
	in.	mm	in.	mm	in.	mm	in.	mm	in.	mm	in.	mm
SBA-12	24	610	2	51	18	457	8	203	15	381	6	152
SBA-18	30	762	6	152	20	508	7	178	15	381	0	0
PBA-12	26	660	3	76	20	508	7	178	17	432	8	203
PBA-18	32	813	8	203	22	559	6	152	17	432	2	51

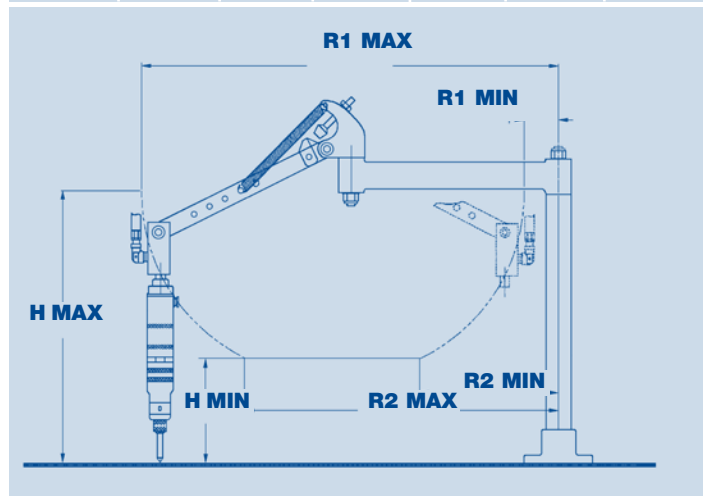

Single Arms		Parallel Arms		Dimensions							
Model No.	Code No.	Model No.	Code No.	A		B		C		D	
				in.	mm	in.	mm	in.	mm	in.	mm

Air Cylinder Models

CSBA18	520160	CPBA-18	520170	12	305	18	457	18	457	-	-
CSBA-24	520200			12	305	24	610	18	457	-	-
CSBA-30	520201	CPBA-30	520203	12	305	30	762	18	457	-	-
CSBA-12-AH	520165	CPBA-12-AH	520178	12	305	12	305	-	-	30	762
CSBA-18-AH	520162	CPBA-18-AH	520172	12	305	18	457	-	-	30	762
CSBA-30-AH	520167	CPBA-30-AH	520215	12	305	30	762	-	-	30	762
		CPBA-30-WM	520207	12	305	30	762	-	-	-	-

Spring Models

SBA-12	520001	PBA-12	520007	12	305	12	305	18	457	-	-
SBA-18	520004	PBA-18	520010	12	305	18	457	18	457	-	-
		PBA-24	520045	12	305	24	610	18	457	-	-
SBA-12-AH	520003	PBA-12-AH	520009	12	305	12	305	-	-	30	762
SBA-18-AH	520006	PBA-18-AH	520012	12	305	18	457	-	-	30	762
SBA-24-AH	520110	PBA-24-AH	520047	12	305	24	610	-	-	30	762
SBA-30-AH	520044	PBA-30-AH	520050	12	305	30	762	-	-	30	762
		PBA-18-18-AH	520036	18	457	18	305	-	-	30	762
		PBA-12-WM	520008	12	305	12	305	-	-	-	-
SBA-30-WM	520043			12	305	30	762	-	-	-	-

AH = Adjustable Height WM = Wall Mounted
 Tool weight capacity: 10 lbs. (4.6 kg) Air Cylinder models
 5 lbs. (2.3 kg) Spring models
 Torque capacity: 10 ft. lbs. (13.5 Nm)

Standard Equipment: Operating Instructions and Service Manual.
 Regulator for Air Cylinders.
 Threaded Nipples for CSBA Models
 1/4 NPT Hex Nipple: 204032 1/4 NPT x 1/8 NPT Hex
 Reducer Nipple: 204137
Optional Equipment: Additional accessories: See page 71.

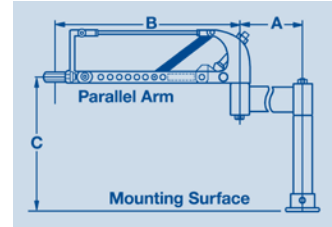
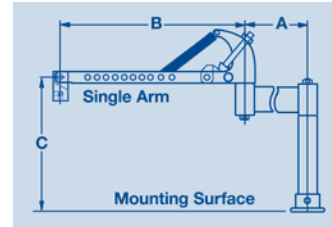

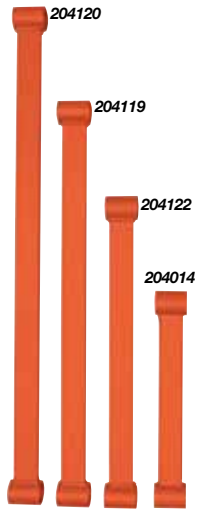

Articulating Arm Extensions

Part Number	Length (inches)
204014	12
204122	18
204119	24
204120	30

Conversion Kits for Cleco Screwdriver Balance Arms

To Convert Balance Arms		Part No.
From	To	
SBA-12	PBA-12*	521041
SBA-18	PBA-18*	521042
Spring	Cylinder	201606
SBA or PBA Standard Duty	SBA or PBA Heavy Duty**	521060

*Conversion kits for -24 and -30 models are available upon request.
**Has four springs to support heavier tools or longer arms.

Tool Holders

Part Number	Description
301128	18/48 Pistol-Horiz. Tool Holder
301129	18/48 Pistol- Vert. Tool Holder
301130	18/48 Inline-Horiz. Tool Holder
301131	18/48 Inline-Vert. Tool Holder

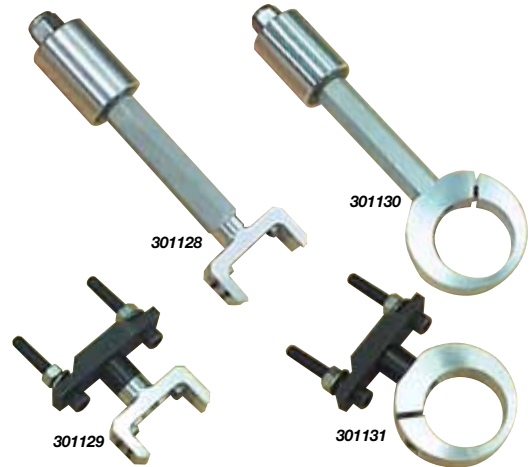

Ergonomic Tool Balancers

Capacity:
0.5 – 20.5 kg
1.0 – 45 Lbs

- External tension Adjustment
- 360° Swivel
- Retracting In-Line Cable



Model No.	Lock Feature	Capacity		"A"		"B"		"C"		Weight	
		lbs.	kg	in.	mm	in.	mm	in.	mm	lbs.	kg
Light Duty – 4.6 ft. (1.4m) Cable Travel											
PL-12A	-	12.0-1.0	5.5-0.5	6.8	171	5.1	130	2.3	58	-	-
Light Duty – 5.0 ft. (1.5m) Cable Travel											
200427	-	2.0-0	.9-0	10.9	277	4.4	112	1.6	41	1.3	0.6
200428	-	4.0-2.0	1.8-9	10.9	277	4.4	112	1.6	41	1.3	0.6
200429	-	5.0-3.0	2.3-1.4	10.9	277	4.4	112	1.6	41	1.3	0.6
Light Duty – 5.2 ft. (1.6m) Cable Travel											
BL-2A	-	2.0-1.0	0.9-0.5	10.4	263	4.0	102	2.2	56	1.1	0.5
BL-4A	-	4.0-2.0	1.8-0.9	10.4	263	4.0	102	2.2	56	1.1	0.5
Light Duty – 6.7 ft. (2.0m) Cable Travel											
BL-6A	-	6.0-4.0	2.7-1.8	12.9	327	5.5	140	3.1	79	3.3	1.5
BLL-6A	Ratchet	6.0-4.0	2.7-1.8	12.9	327	5.5	140	3.1	79	3.3	1.5
BL-8A	-	8.0-6.0	3.6-2.7	12.9	327	5.5	140	3.1	79	3.3	1.5
BLL-8A	Ratchet	8.0-6.0	3.6-2.7	12.9	327	5.5	140	3.1	79	3.3	1.5
Medium Duty – 6.6ft. (2.0m) Cable Travel											
BM-13A	Automatic	13-9.0	5.9-4.1	13.8	350	6.9	175	4.5	114	9.0	4.1
BML-13A	Automatic/Ratchet	13-9.0	5.9-4.1	13.8	350	6.9	175	4.5	114	9.0	4.1
BM-18A	Automatic	18-13	8.2-5.9	13.8	350	6.9	175	4.5	114	9.0	4.1
Medium Duty – 6.0ft. (1.8m) Cable Travel											
BM-25A	Automatic	25-18	11.4-8.2	20.7	527	7.8	197	6.6	169	19	8.6
BM-35A	Automatic	35-25	15.9-11.4	20.7	527	7.8	197	6.6	169	19	8.6
BM-45A	Automatic	45-35	20.5-15.9	20.7	527	7.8	197	6.6	169	19	8.6

*4.9 ft. cable travel

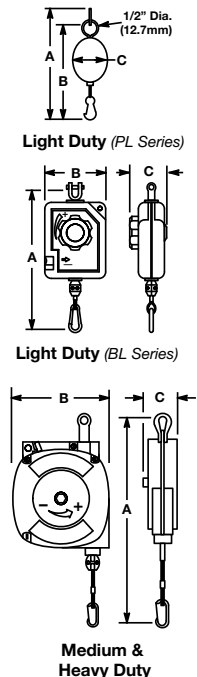

Articulating Support Arms

The basic underlying reason for the use of an articulating arm is to improve productivity through applied ergonomics. A manufacturer cannot ignore the pressure to improve productivity of employees because of the impact productivity has on the bottom line.

Automated Systems offers an articulating arm that can be designed for your suspension application. Articulating arms are also called tool balance arms. Automated Systems' HDA series articulating arms are sized and designed to accommodate different size tools and mounting brackets required for specific applications. The arm can be suspended from an overhead rail,

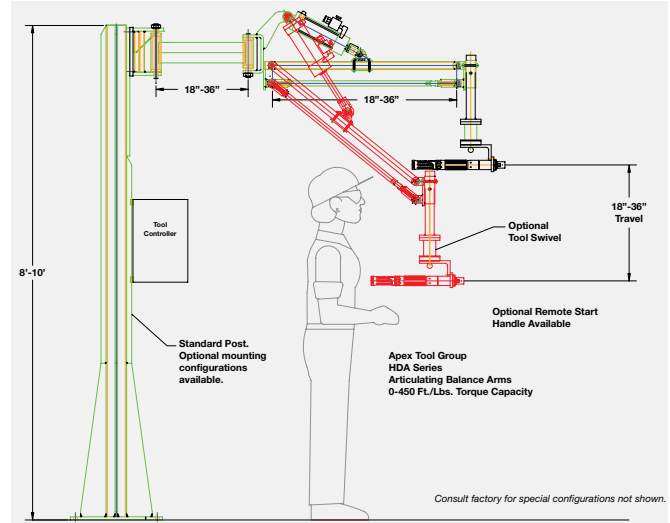

structural column, ceiling mounted or post. The tool is typically mounted on the end of the arm.

Uses for Articulating Arms	Typical Articulating Arm Features	Optional Features
<ul style="list-style-type: none"> ■ Stop or AGV stations ■ Slow moving conveyor arms ■ Work cells ■ Side or overhead tool position work 	<ul style="list-style-type: none"> ■ Single or parallel arms ■ Arm leveling base ■ Boom ■ Air balancing cylinder ■ Mounting end ■ Lift arm 	<ul style="list-style-type: none"> ■ Pneumatic or electric disc brake

Cable Management

Automated Systems can provide you with assistance ranging from concept to installation of an efficient cable management solution. Automated Systems equipment uses cables in conjunction with hand held tools, fixtured hand tools or when nutrunners are provided for incorporation into automated systems.

Cables need to be protected throughout their routing. We protect the cables from machine movement, equipment, chaffing, sharp objects, vibration, heat and liquid.

We have a full support staff of Sales Engineers, Mechanical Engineers, Controls Engineers, Project Managers, Field Service Engineers and In-house Service Engineers waiting to serve you.

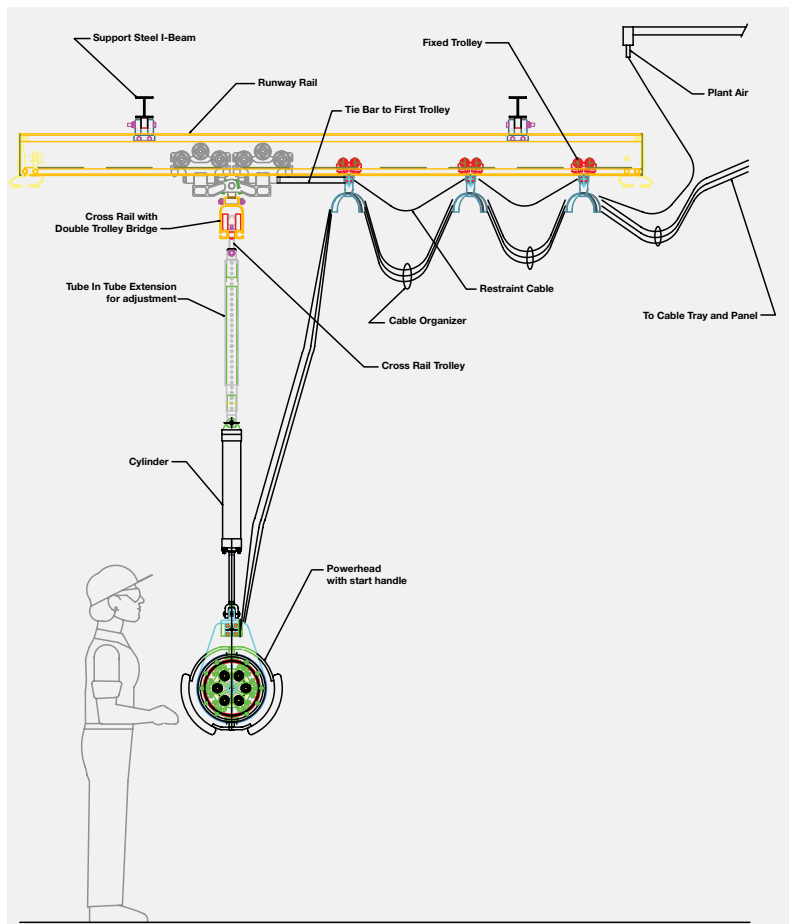

Typical two spindle multiple with Intelligent spindle open frame, horizontal compliance device and operator interface box.

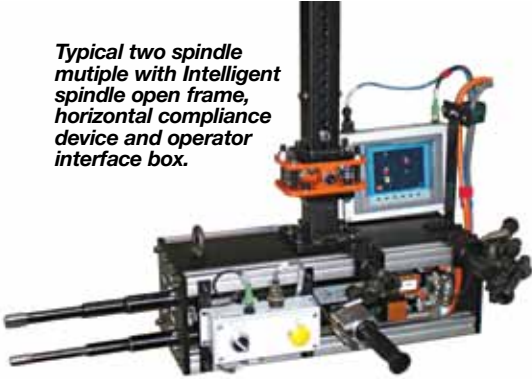

Repair bay operator is using a two spindle fixtured tool to fasten components of a wheel hub assembly.

Modular Handling Systems for Handheld Nutrunners & Tightening Spindles

Advantages

- High flexibility/adaptability to your fastening application
- Compact and coordinated system
- Effortless handling
- Can handle DGD and EMT spindles as well as Cleco DC nutrunners
- Modular components means short delivery times

Standard Features

- Dual start/stop handles
- Lightweight aluminum covers & frame
- E-stop
- Ease of service. Easy spindle removal for maintenance or calibration
- Remote spindle indicator lights

- 2 inch retractable spindle travel
- On-powerhead calibration
- Extended support tubes

Optional Features

- Powerhead kick-off from wheel
- Remote digital display (MMI)

- Headlights
- Adjustable spindle centers
- Auto spindle retraction for multi-product assembly lines
- Fabricated steel suspension arm
- Part detection

Typical Torque Handling System Configurations

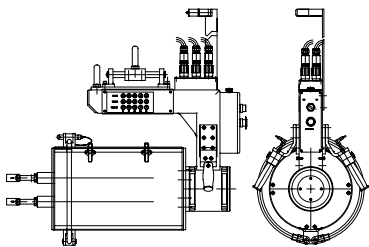

Horizontal Rear Trunion Mount
(Wheelnut Application)

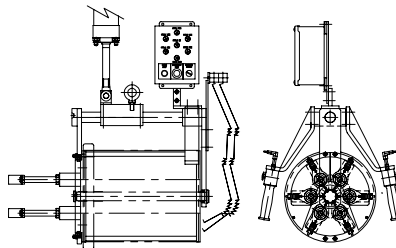

Horizontal Front Trunion Mount
(Wheelnut Application)

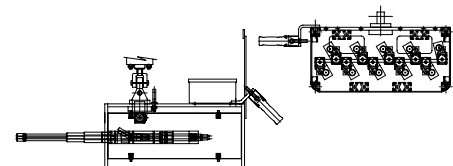

Horizontal Enclosure
(Exhaust Manifold Application)

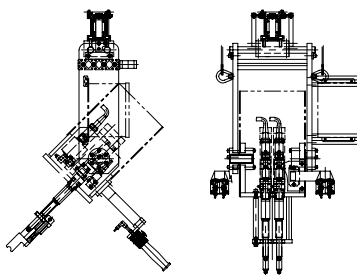

Angled Down Swivel Open Frame
(Rocker Application)

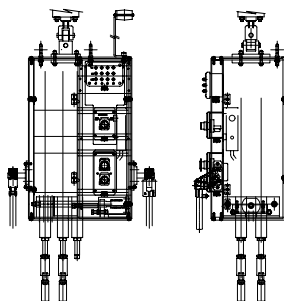

Vertical Down Enclosure
(U-bolt Application)

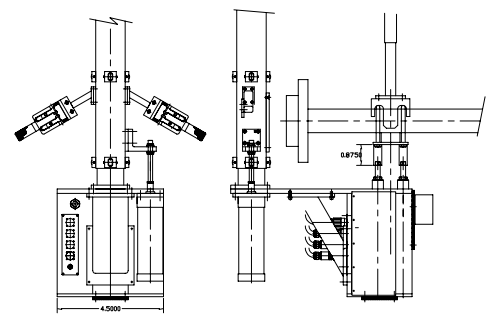

Vertical Up Enclosure
(U-bolt Application)



Quality Fastener Tools

For more than half a century Apex has maintained the position of world leader in industrial fastening tools. Many power and insert bits, socket combinations and other drivers/adapters pioneered by Apex have today become industry standards, while Apex quality, service and selection give you unsurpassed value.

More Quality For Your Money

Apex quality starts with the selection of raw materials. Only carefully chosen, high grade tool steel is used to make Apex industrial fastener tools. Next, each tool is precision machined from solid bar stock to exacting standards of accuracy. You always get a snug, secure fit – a fit that is not possible from stamped tools.

Finally, each Apex fastener tool is tempered with our exclusive heat treating process. During this step the degree of hardness is determined based upon the application.

Fast Delivery

All Apex standard catalog items are available off-the-shelf for immediate delivery. If you need special assistance with your order, your Apex manufacturer's representative can handle any questions you may have.

Special Orders

Apex offers the broadest selection of screw driver and nut runner tools available, from bits, sockets and universal wrenches to extensions, adapters and nut setters. If you have a special application, contact your Apex representative. We may have what you need in stock, or can design and produce special fastener tools for almost any application.

Ordering Information

Apex products are distributed world-wide. For a catalog of the complete line of Apex quality fastener tools or to locate your nearest Apex distributor, visit our website at www.apex-tools.com.

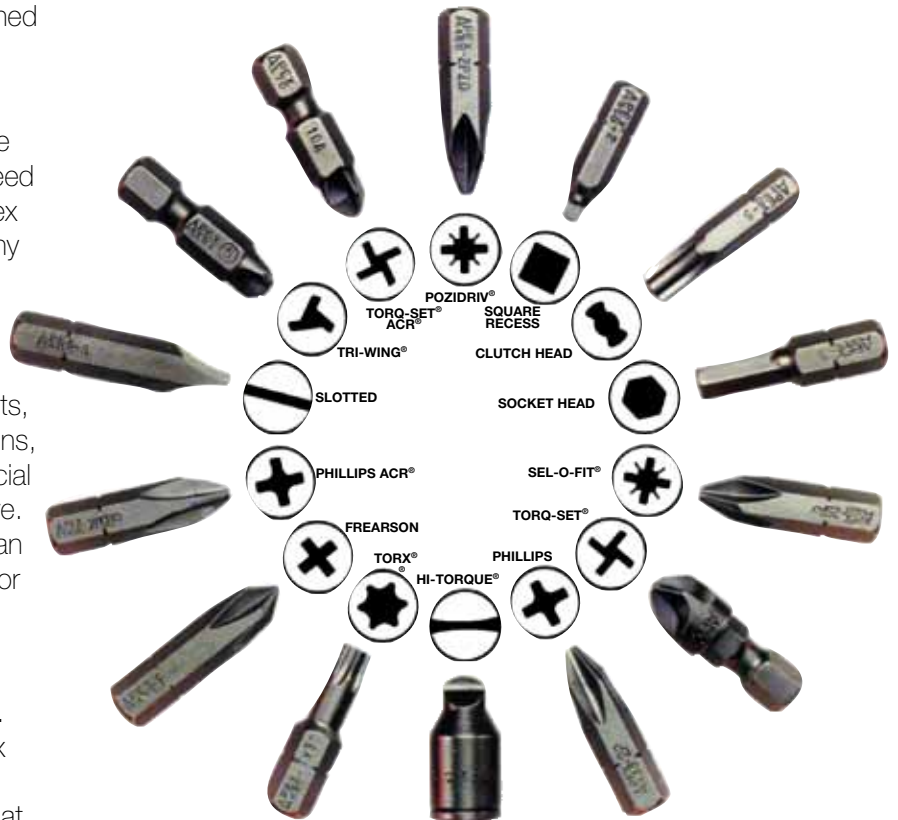

APEX® Guard™

Quality Anti-Mar Fastener Tools Begin With Quality Fastener Tools.

Apex **μ-Guard™** provides a protective barrier between genuine Apex fastener tools and your finely finished workpiece. The free-spinning patent-pending design provides maximum protection for polished and highly sensitive surfaces.

Apex **μ-Guard™** covering is made of a thermo plastic urethane (TPU elastomer) which cushions against costly incidental side impacts. It offers the lowest coefficient of friction for maximum tool efficiency. It is also non-removable for tamper resistance.

With Apex **μ-Guard™** you get the proven Apex fastener tool fit and performance plus the best protection available against marring and in-system damage.

μ-Guard™ is your guard against the potential hazards caused by rotational friction.



If it doesn't say Apex on the outside, how can you be sure of what's on the inside?

Prevents Side Impact Damage



Free-Spinning Design



Virtually Damage Free



Conversion Tables

Millimeter – Decimal – Fraction

mm	Dec.	in.	mm	Dec.	in.	mm	Dec.	in.	mm	Dec.	in.	mm	Dec.	in.
0.100	.0039		5.159	.2031	13/64	10.300	.4055		15.400	.6063		20.400	.8031	
0.200	.0079		5.200	.2047		10.319	.4063	13/32	15.478	.6094	39/64	20.500	.8071	
0.300	.0118		5.300	.2087		10.400	.4094		15.500	.6102		20.600	.8110	
0.397	.0156	1/64	5.400	.2126		10.500	.4134		15.600	.6142		20.638	.8125	13/16
0.400	.0157		5.500	.2165		10.600	.4173		15.700	.6181		20.700	.8150	
0.500	.0197		5.556	.2188	7/32	10.700	.4219		15.800	.6220		20.800	.8189	
0.600	.0236		5.600	.2205		10.716	.4219	27/64	15.875	.6250	5/8	20.900	.8228	
0.700	.0276		5.700	.2244		10.800	.4252		15.900	.6250		21.000	.8268	
0.794	.0313	1/32	5.800	.2283		10.900	.4291		16.000	.6299		21.034	.8182	53/64
0.800	.0315		5.900	.2323		11.000	.4331		16.100	.6339		21.100	.8307	
0.900	.0354		5.953	.2344	15/64	11.100	.4370		16.200	.6378		21.200	.8307	
1.000	.0394		6.000	.2362		11.113	.4375	7/16	16.272	.6406	41/64	21.200	.8346	
1.100	.0433		6.100	.2402		11.200	.4409		16.300	.6417		21.300	.8386	
1.191	.0469	3/64	6.200	.2441		11.300	.4449		16.400	.6457		21.400	.8425	
1.200	.0472		6.300	.2480		11.400	.4488		16.500	.6496		21.431	.8438	27/32
1.300	.0512		6.350	.2500	1/4	11.500	.4528		16.600	.6535		21.500	.8465	
1.400	.0551		6.400	.2520		11.509	.4531	29/64	16.669	.6563	21/32	21.600	.8504	
1.500	.0591		6.500	.2559		11.600	.4567		16.700	.6575		21.700	.8543	
1.588	.0625	1/16	6.600	.2598		11.700	.4606		16.800	.6614		21.800	.8583	
1.600	.0630		6.700	.2638		11.800	.4646		16.900	.6654		21.828	.8594	55/94
1.700	.0669		6.747	.2656	17/64	11.900	.4685		17.000	.6693		21.900	.8622	
1.800	.0709		6.800	.2677		11.906	.4688	15/32	17.066	.6719	43/64	22.000	.8661	
1.900	.0748		6.900	.2717		12.000	.4724		17.100	.6732		22.100	.8701	
1.984	.0781	5/64	7.000	.2756		12.100	.4764		17.200	.6772		22.200	.8740	
2.000	.0878		7.100	.2795		12.200	.4803		17.300	.6811		22.225	.8750	7/8
2.100	.0827		7.144	.2813	9/32	12.300	.4843		17.400	.6850		22.300	.8780	
2.200	.0866		7.200	.2835		12.303	.4844	31/64	17.463	.6875	11/16	22.400	.8819	
2.300	.0906		7.300	.2874		12.400	.4882		17.500	.6890		22.500	.8858	
2.381	.0938	3/32	7.400	.2913		12.500	.4921		17.600	.6929		22.600	.8898	
2.400	.0945		7.500	.2953		12.600	.4961		17.700	.6968		22.622	.8906	57/64
2.500	.0984		7.541	.2969	19/64	12.700	.5000	1/2	17.800	.7008		22.700	.8937	
2.600	.1024		7.600	.2992		12.800	.5039		17.859	.7031	45/64	22.800	.8976	
2.700	.1063		7.700	.3031		12.900	.5079		17.900	.7047		22.900	.9016	
2.778	.1094	7/64	7.800	.3071		13.000	.5118		18.000	.7087		23.000	.9055	
2.800	.1102		7.900	.3110		13.097	.5156	33/64	18.100	.7126		23.019	.9063	29/32
2.900	.1142		7.938	.3125	5/16	13.100	.5157		18.200	.7165		23.100	.9094	
3.000	.1181		8.000	.3150		13.200	.5197		18.256	.7188	23/32	23.200	.9134	
3.100	.1220		8.100	.3189		13.300	.5236		18.300	.7205		23.300	.9173	
3.175	.1250	1/8	8.200	.3228		13.400	.5276		18.400	.7244		23.400	.9213	
3.200	.1260		8.300	.3268		13.494	.5313	17/32	18.500	.7283		23.416	.9219	59/64
3.300	.1299		8.334	.3281	21/64	13.500	.5315		18.600	.7323		23.500	.9252	
3.400	.1339		8.400	.3307		13.600	.5354		18.653	.7344	47/64	23.600	.9291	
3.500	.1378		8.500	.3346		13.700	.5394		18.700	.7362		23.700	.9331	
3.572	.1406	9/64	8.600	.3386		13.800	.5433		18.800	.7402		23.800	.9370	
3.600	.1417		8.700	.3425		13.891	.5469	35/64	18.900	.7441		23.900	.9409	
3.700	.1457		8.731	.3438	11/32	13.900	.5472		19.000	.7480		24.000	.9449	
3.800	.1496		8.800	.3465		14.000	.5512		19.050	.7500	3/4	24.100	.9488	
3.900	.1535		8.900	.3504		14.100	.5551		19.100	.7520		24.200	.9528	
3.969	.1563	5/32	9.000	.3543		14.200	.5591		19.200	.7559		24.209	.9531	61/64
4.000	.1575		9.100	.3583		14.288	.5625	9/16	19.300	.7598		24.300	.9567	
4.100	.1624		9.128	.3594	23/64	14.300	.5630		19.400	.7638		24.400	.9606	
4.200	.1654		9.200	.3622		14.400	.5669		19.447	.7656	49/64	24.500	.9646	
4.300	.1693		9.300	.3661		14.500	.5709		19.500	.7677		24.600	.9685	
4.366	.1719	11/64	9.400	.3701		14.600	.5748		19.600	.7717		24.606	.9688	31/32
4.400	.732		9.500	.3740		14.684	.5781	37/64	19.700	.7756		24.700	.9724	
4.500	.1772		9.525	.3750	3/8	14.700	.5787		19.800	.7795		24.800	.9764	
4.600	.1811		9.700	.3819		14.800	.5827		19.844	.7813	25/32	24.900	.9803	
4.700	.1850		9.800	.3858		14.900	.5866		19.900	.7835		25.000	.9843	
4.763	.1875	3/16	9.900	.3898		15.000	.5906		20.000	.7874		25.003	.9844	63/64
4.800	.1890		9.922	.3902	25/64	15.081	.5938	19/32	20.100	.7913		25.100	.9882	
4.900	.1929		10.000	.3937		15.100	.5945		20.200	.7953		25.200	.9921	
5.000	.1969		10.100	.3976		15.200	.5984		20.241	.7969	51/64	25.300	.9961	
5.100	.2008		10.200	.4016		15.300	.6024		20.300	.7992		25.400	1.000	1

Torque Conversion Factors		
To Convert	Into	Multiply By
Inch Pounds	Foot Pounds	0.0835
Inch Pounds	Newton meters	0.1130
Inch Pounds	Kg-meters	0.0115
Inch Pounds	Kg-Cm	1.1519
Foot Pounds	Inch Pounds	12.000
Foot Pounds	Newton meters	1.3560
Foot Pounds	Kg-meters	0.1382
Foot Pounds	Kg-Cm	13.8240
Newton Meters	Inch Pounds	8.8440
Newton Meters	Foot Pounds	0.7370
Newton Meters	Kg-meters	0.1020
Newton Meters	Kg-Cm	10.2000
Kg meters	Inch Pounds	86.8100
Kg meters	Foot Pounds	7.2340
Kg meters	Newton-meters	9.8040
Kg Cm	Inch Pounds	0.8681
Kg Cm	Foot Pounds	0.0723
Kg Cm	Newton-meters	0.0980

Torque Conversion – In. Lbs. (Nm)					
In. Lbs.	Nm	In. Lbs.	Nm	In. Lbs.	Nm
5	0.6	50	5.7	140	15.8
10	1.1	60	6.8	150	17.0
15	1.7	70	7.9	160	18.1
20	2.3	80	9.0	170	19.2
25	2.8	90	10.2	180	20.3
30	3.4	100	11.3	190	21.5
35	4.0	110	12.4	200	22.6
40	4.5	120	13.6		
45	5.1	130	14.7		

Torque Conversion – Ft. Lbs. (Nm)							
Ft. Lbs.	Nm	Ft. Lbs.	Nm	Ft. Lbs.	Nm	Ft. Lbs.	Nm
1	1.36	33	44.8	65	88.1	97	131.5
2	2.7	34	46.1	66	90.0	98	133.0
3	4.1	35	47.5	67	90.9	99	134.2
4	5.4	36	48.8	68	92.2	100	135.6
5	6.8	37	50.2	69	93.6	110	149.2
6	8.1	38	52.0	70	94.9	115	156.0
7	9.5	39	52.9	71	96.3	120	163.0
8	10.9	40	54.2	72	97.6	125	170.0
9	12.2	41	55.6	73	99.0	130	176.3
10	13.6	42	57.0	74	100.3	135	183.1
11	14.9	43	58.3	75	102.0	140	190.0
12	16.3	44	60.0	76	103.1	145	197.0
13	17.6	45	61.0	77	104.4	150	203.4
14	19.0	46	62.4	78	105.8	155	210.2
15	20.3	47	63.7	79	107.1	160	217.0
16	21.7	48	65.1	80	108.5	165	224.0
17	23.1	49	66.4	81	110.0	170	231.0
18	24.4	50	67.8	82	111.2	175	237.3
19	25.8	51	69.2	83	112.6	180	244.1
20	27.1	52	70.5	84	114.0	185	251.0
21	28.5	53	71.9	85	115.3	190	258.0
22	29.8	54	73.2	86	117.0	195	264.4
23	31.2	55	74.6	87	118.0	200	271.2
24	32.5	56	75.9	88	119.3	225	305.1
25	33.9	57	77.3	89	121.0	250	339.0
26	35.3	58	78.7	90	122.0	275	373.0
27	36.6	59	80.0	91	123.4	300	407.0
28	38.0	60	81.4	92	125.0	350	475.0
29	39.3	61	82.7	93	126.1	400	542.4
30	40.7	62	84.1	94	127.5		
31	42.0	63	85.4	95	129.0		
32	43.4	64	86.8	96	130.2		

Inch Bolt Torque Table

SAE J429 and ASME 574

Steel Grade	SAE 5		SAE 8		Socket Head Cap Screws	
	Dry	Lubed	Dry	Lubed	Dry	Lubed
1/4-20	(101)	(76)	(143)	(107)	(168)	(120)
1/4-28	(116)	(87)	(147)	(123)	(192)	(144)
5/16-18	(209)	(157)	(295)	(221)	(348)	(264)
5/16-24	(231)	(174)	(327)	(245)	(384)	(288)
3/8-16	(372)	(276)	44	33	51	38
3/8-24	(420)	(312)	49	37	58	43
7/16-14	49	37	70	52	81	61
7/16-20	55	41	78	58	91	68
1/2-13	75	57	106	80	124	93
1/2-20	85	64	120	90	140	105
5/8-11	150	113	212	159	238	179
5/8-18	170	127	240	180	270	202
3/4-10	267	200	376	282	423	317
3/4-16	297	223	420	315	472	354
7/8-9	429	322	606	455	682	511
7/8-14	474	355	669	502	752	564
1-8	644	483	909	681	1022	767
1-12	722	542	1020	765	1147	860

Metric Bolt Torque Table

ISO 898

Property Class	8.8		10.9		12.9 Socket Head Cap Screw	
	Torque in Newton Meter - Nm					
Nom Size x Pitch	Dry	Lubed	Dry	Lubed	Dry	Lubed
M5 x 0.80	6.1	4.6	8.8	6.7	10.3	7.7
M6 x 1.00	10.4	7.8	15	11.2	17.6	13.1
M7 x 1.00	17.6	13.1	25.1	18.9	29.4	22
M8 x 1.25	25.4	19.1	37.6	27.3	42.6	32.1
M10 x 1.50	50	38	72	54	84	64
M12 x 1.75	88	66	126	94	146	110
M14 x 2.00	141	106	201	150	235	176
M16 x 2.00	218	164	312	233	365	274
M18 x 2.50	301	226	431	323	504	378
M20 x 2.50	426	319	609	457	712	534
M22 x 2.50	580	435	831	624	971	728
M24 x 3.00	736	552	1052	789	1231	923
M27 x 3.00	1079	809	1544	1158	1805	1353
M30 x 3.50	1463	1097	2092	1570	2446	1834
M33 x 3.50	1990	1493	2849	2137	3328	2497
M36 x 4.00	2557	1918	3659	2744	4276	3208

Lubed means cleaned dry bolts lubricated with a standard medium viscosity machine oil. Lubricate all contact areas of the bolts and washers. Lubricating the bolts is the suggested method.

Miscellaneous Conversion Factors			Air Pressure Conversion		
To Convert	Into	Multiply By	PSI	kPa*	Bar**
Inches	Millimeters	25.4000	85	586	5.9
Millimeters	Inches	0.0394	90	620	6.2
Pounds	Kilograms	0.4536	95	655	6.6
Kilograms	Pounds	2.2050	100	690	6.9
psi	bar	0.069	125	860	8.6
bar	psi	14.5			

*Preferred: Approximate to the nearest 5 kPa.
**Approximate to the nearest 0.5 Bar.

One Of The Broadest Range Of Tools In The World Is At Your Fingertips!

Apex Tool Group covers a wide range of industrial markets, including aerospace, automotive, foundries, furniture, general industry, metal fabrication, petroleum, power generation, shipbuilding, and transportation. These markets have been served by Apex Tool Group's brands for many decades, by offering our customers solutions and products that meet their demanding productivity requirements.

To receive a product catalog quickly, just go to www.apexpowertools.com or apexpowertools.eu. Select the literature you want. Then complete the "Contact Information" form, hit "Submit Request" and your order will be processed immediately. Materials normally arrive within 48 hours.

Below are a few of our more popular power tools catalogs



Apex Fastener Tools
A comprehensive line of industrial quality bits, finders, sockets and extensions.
(Catalog # TC-100)
www.apex-tools.com



Dotco/Cleco Material Removal Tools
A full line of pneumatic material removal tools including drills, sanders, and grinders.
(Catalog # SP-102)
www.dotco-tools.com



Master Power Industrial Air Tools
A complete line of industrial pneumatic tools for assembly and material removal applications.
(Catalog # SP-904)
www.masterpowertools.com



Apex Universal Joints
Industrial quality universal joints that can be custom designed for most any application.
(Catalog # SP-1400)
www.apexuniversal.com



DGD Assembly Systems
A complete line of spindles, D.C. electric assembly tools and controllers for the MV.
(Catalog # SP-703DE/EN)
www.apexpowertools.eu



Utica Torque Products
A full line of torque measuring products including torque screwdrivers, torque wrenches and analyzers.
(Catalog # SP-301)
www.uticatools.com



Cleco Pneumatic Assembly Tools
A full line of industrial pneumatic assembly tools from screwdrivers to nutrunners to impacts.
(Catalog # SP-1000)
www.clecotools.com



Cleco Power Motors
A comprehensive line of industrial pneumatic motors for a multitude of applications.
(Catalog # SP-104)
www.clecotools.com



Airetool Tube Cleaners & Expanders
A complete line of industrial tube cleaners, expanders and installation tools.
(Catalog # SP-1100)
www.airetools.com



Cleco D.C. Electric Assembly Tools
A complete line of industrial D.C. electric assembly tools and controllers.
(Catalog # SP-1020)
www.clecotools.com

Model	Page	Model	Page	Model	Page	Model	Page	Model	Page
2200427	129	35007004	126	18EAE08AL2	32	1BTS-1B012A-2/1K3B-1ZB	75	1BUTSE-1B060A-1WM2B	65
200428	129	43287131	126	18EAE15AM3	32	1BTS-1B035A-1K1B-1VK1B	75	2BB-2B100A-2/2K1M-2ZA	97
200429	129	45017152	126	18EAE16F1	41	1BTS-1B035A-1K1B-1WK1B	75	2BB-2B100A-2K1M-2VK1M	97
201606	129	48316033	126	18EAE16S131	44	1BTS-1B035A-1K1B-1ZB	73	2BB-2B100A-2K1M-2WK1M	97
204014	129	49097101	126	18EAE16S131	111	1BTS-1B035A-1VK1B	73	2BB-2B100A-2K1M-2ZA	95
204119	129	57217101	126	18EAE22AM3	32	1BTS-1B035A-1WK1B	73	2BB-2B100A-2VK1M	95
204120	129	99248150	124	18EAE23F1	41	1BTS-1B035A-2/1K1B-1ZB	75	2BB-2B100A-2WK1M	95
204122	129	99249101	124	18EAE23S131	44	1BTS-1B060A-1K2B-1VK2B	75	2BB-2B150A-2/2K2M-2ZA	97
205832	126	99249102	124	18EAE23S131	111	1BTS-1B060A-1K2B-1WK2B	75	2BB-2B150A-2K2M-2VK2M	97
205834	126	99249103	124	18EAE28AM3	32	1BTS-1B060A-1K2B-1ZB	73	2BB-2B150A-2K2M-2WK2M	97
205838	126	99249104	124	18EAE30F1	41	1BTS-1B060A-1VK2B	73	2BB-2B150A-2K2M-2ZA	95
301128	129	99249147	124	18EAE30S131	44	1BTS-1B060A-1WK2B	73	2BB-2B150A-2VK2M	95
301129	129	99249148	124	18EAE30S131	111	1BTS-1B060A-2/1K2B-1ZB	75	2BB-2B150A-2WK2M	95
301130	129	99249156	124	18EPE06D2	36	1BTSE-1B012A-1M3B-1ZB	65	2BTS-2B110A-2/2K1B-2ZB	79
301131	129	99249157	124	18EPE06D3P	37	1BTSE-1B012A-1VM3B	65	2BTS-2B110A-2K1B-2VK1B	79
301837	123	99249158	124	18EPE06Q	36	1BTSE-1B012A-1WM3B	65	2BTS-2B110A-2K1B-2WK1B	79
521041	129	99249159	124	18EPE06QP	37	1BTSE-1B035A-1M1B-1ZB	65	2BTS-2B110A-2K1B-2ZB	77
521042	129	99249160	124	18EPE12D3	36	1BTSE-1B035A-1VM1B	65	2BTS-2B110A-2VK1B	77
521060	129	99249161	124	18EPE12D3P	37	1BTSE-1B035A-1WM1B	65	2BTS-2B110A-2WK1B	77
535833	126	99249162	124	18EPE12Q	36	1BTSE-1B060A-1M2B-1ZB	65	2BTS-2B200A-2/2K3B-2ZB	79
536185	125	99249163	124	18EPE12QP	37	1BTSE-1B060A-1VM2B	65	2BTS-2B200A-2K3B-2VK3B	79
541715	126	99249164	124	18EPE17D3	36	1BTSE-1B060A-1WM2B	65	2BTS-2B200A-2K3B-2WK3B	79
541757	125	99249165	124	18EPE17Q	36	1BUB-1B011A-1K3MS-1VK3MS	93	2BTS-2B200A-2K3B-2ZB	77
542428	126	99249169	124	18EPE22D3	36	1BUB-1B011A-1K3MS-1WK3MS	93	2BTS-2B200A-2VK3B	77
542972	124	99249181	124	18EPE31D3	36	1BUB-1B011A-1K3MS-1ZA	91	2BTS-2B200A-2WK3B	77
542973	124	17BPYSB05Q	29	18ESE06D2	37	1BUB-1B011A-1VK3MS	91	2BTSE-2B110A-2M1B-2ZB	67
542974	124	17BPYSB07Q	29	18ESE06D3P	34	1BUB-1B011A-1WK3MS	91	2BTSE-2B110A-2VM1B	67
542975	124	17BPYSB09Q	29	18ESE06Q	34	1BUB-1B011A-2/1K3MS-1ZA	93	2BTSE-2B110A-2WM1B	67
542991	125	17BPYSB13Q	29	18ESE06QP	37	1BUB-1B030A-1K1M-1VK1M	93	2BTSE-2B200A-2M3B-2ZB	67
543070	126	18CAE08AL2	48	18ESE06ZA	38	1BUB-1B030A-1K1M-1WK1M	93	2BTSE-2B200A-2VM3B	67
543071	126	18CAE15AM3	48	18ESE06ZA	111	1BUB-1B030A-1K1M-1ZA	91	2BTSE-2B200A-2WM3B	67
543230	126	18CAE16F1	54	18ESE12D3	34	1BUB-1B030A-1VK1M	91	2BUB-2B100A-2/2K1M-2ZA	97
543232	126	18CAE16S131	56	18ESE12D3P	37	1BUB-1B030A-1WK1M	91	2BUB-2B100A-2K1M-2VK1M	97
543235	126	18CAE22AM3	48	18ESE12Q	34	1BUB-1B030A-2/1K1M-1ZA	93	2BUB-2B100A-2K1M-2WK1M	97
543414	125	18CAE23F1	54	18ESE12QP	37	1BUB-1B050A-1K2M-1VK2M	93	2BUB-2B100A-2K1M-2ZA	95
544197	112	18CAE23S131	56	18ESE12ZA	38	1BUB-1B050A-1K2M-1WK2M	93	2BUB-2B100A-2VK1M	95
550006	125	18CAE28AM3	48	18ESE12ZA	111	1BUB-1B050A-1K2M-1ZA	91	2BUB-2B100A-2WK1M	95
910609	113	18CAE30F1	54	18ESE17D3	34	1BUB-1B050A-1VK2M	91	2BUB-2B150A-2/2K2M-2ZA	97
910613	113	18CAE30S131	56	18ESE17Q	34	1BUB-1B050A-1WK2M	91	2BUB-2B150A-2K2M-2VK2M	97
912106	113	18CPE06D2	50	18ESE17ZA	38	1BUB-1B050A-2/1K2M-1ZA	93	2BUB-2B150A-2K2M-2WK2M	97
912147	113	18CPE06D3P	51	18ESE17ZA	111	1BUTS-1B012A-1K3B-1VK3B	75	2BUB-2B150A-2K2M-2ZA	95
916642	113	18CPE06Q	50	18ESE22D3	34	1BUTS-1B012A-1K3B-1WK3B	75	2BUB-2B150A-2VK2M	95
916643	113	18CPE06QP	51	18ESE31D3	34	1BUTS-1B012A-1K3B-1ZB	73	2BUB-2B150A-2WK2M	95
929041	113	18CPE12D3	50	1BB-1B011A-1K3MS-1VK3MS	93	1BUTS-1B012A-1VK3B	73	2BUTS-2B110A-2/2K1B-2ZB	79
929053	113	18CPE12D3P	51	1BB-1B011A-1K3MS-1WK3MS	93	1BUTS-1B012A-1WK3B	73	2BUTS-2B110A-2K1B-2VK1B	79
929061	113	18CPE12Q	50	1BB-1B011A-1K3MS-1ZA	91	1BUTS-1B012A-2/1K3B-1ZB	75	2BUTS-2B110A-2K1B-2WK1B	79
929065	113	18CPE12QP	51	1BB-1B011A-1VK3MS	91	1BUTS-1B035A-1K1B-1VK1B	75	2BUTS-2B110A-2K1B-2ZB	77
929077	113	18CPE17D3	50	1BB-1B011A-1WK3MS	91	1BUTS-1B035A-1K1B-1WK1B	75	2BUTS-2B110A-2VK1B	77
929089	113	18CPE17Q	50	1BB-1B011A-2/1K3MS-1ZA	93	1BUTS-1B035A-1K1B-1ZB	73	2BUTS-2B110A-2WK1B	77
935144	123	18CPE22D3	50	1BB-1B030A-1K1M-1VK1M	93	1BUTS-1B035A-1VK1B	73	2BUTS-2B200A-2/2K3B-2ZB	79
935154	123	18CPE31D3	50	1BB-1B030A-1K1M-1WK1M	93	1BUTS-1B035A-1WK1B	73	2BUTS-2B200A-2K3B-2VK3B	79
935155	123	18CSE06D2	49	1BB-1B030A-1K1M-1ZA	91	1BUTS-1B035A-2/1K1B-1ZB	75	2BUTS-2B200A-2K3B-2WK3B	79
935157	123	18CSE06D3P	51	1BB-1B030A-1VK1M	91	1BUTS-1B060A-1K2B-1VK2B	75	2BUTS-2B200A-2K3B-2ZB	77
935170	112	18CSE06Q	49	1BB-1B030A-1WK1M	91	1BUTS-1B060A-1K2B-1WK2B	75	2BUTS-2B200A-2VK3B	77
935170	123	18CSE06QP	51	1BB-1B030A-2/1K1M-1ZA	93	1BUTS-1B060A-1K2B-1ZB	73	2BUTS-2B200A-2WK3B	77
935290	123	18CSE06ZA	52	1BB-1B050A-1K2M-1VK2M	93	1BUTS-1B060A-1VK2B	73	2BUTSE-2B110A-2M1B-2ZB	67
935377	123	18CSE12D3	49	1BB-1B050A-1K2M-1WK2M	93	1BUTS-1B060A-1WK2B	73	2BUTSE-2B110A-2VM1B	67
935395	123	18CSE12D3P	51	1BB-1B050A-1K2M-1ZA	91	1BUTS-1B060A-2/1K2B-1ZB	75	2BUTSE-2B110A-2WM1B	67
935396	123	18CSE12Q	49	1BB-1B050A-1VK2M	91	1BUTSE-1B012A-1M3B-1ZB	65	2BUTSE-2B200A-2M3B-2ZB	67
935552	113	18CSE12QP	51	1BB-1B050A-1WK2M	91	1BUTSE-1B012A-1VM3B	65	2BUTSE-2B200A-2VM3B	67
935998	123	18CSE12ZA	52	1BB-1B050A-2/1K2M-1ZA	93	1BUTSE-1B012A-1WM3B	65	2BUTSE-2B200A-2WM3B	67
935999	123	18CSE17D3	49	1BTS-1B012A-1K3B-1VK3B	75	1BUTSE-1B035A-1M1B-1ZB	65	301866-1M	122
961024	125	18CSE17Q	49	1BTS-1B012A-1K3B-1WK3B	75	1BUTSE-1B035A-1VM1B	65	301877-1M	122
961127	88	18CSE17ZA	52	1BTS-1B012A-1K3B-1ZB	73	1BUTSE-1B035A-1WM1B	65	301903-1M	122
961390	123	18CSE22D3	49	1BTS-1B012A-1VK3B	73	1BUTSE-1B060A-1M2B-1ZB	65	301904-1M	122
1110909	125	18CSE31D3	49	1BTS-1B012A-1WK3B	73	1BUTSE-1B060A-1VM2B	65	3BB-3B180A-2/3K1M-3ZA	101

Model Number Index

Model	Page	Model	Page	Model	Page	Model	Page	Model	Page
3BB-3B180A-3K1M-3VK1M.....	101	48CAE230S461.....	56	48EAE28AL3.....	32	4BB-4B360A-2/4K1M-4ZA.....	103	4BUB-4B460A-4K2M-4ZA.....	103
3BB-3B180A-3K1M-3WK1M.....	101	48CAE28AL3.....	48	48EAE37F2.....	41	4BB-4B360A-2/4K1MS-4Z1250A109	107	4BUB-4B460A-4K2MS-4Z1600A105	105
3BB-3B180A-3K1M-3ZA.....	99	48CAE37F2.....	54	48EAE37S231.....	44	4BB-4B360A-4K1M-4VK1M.....	107	4BUB-4B460A-4VK2M.....	103
3BB-3B180A-3VK1M.....	99	48CAE37S231.....	56	48EAE37S231.....	111	4BB-4B360A-4K1M-4WK1M.....	107	4BUB-4B460A-4WK2M.....	103
3BB-3B180A-3WK1M.....	99	48CAE41AM3.....	48	48EAE41AM3.....	32	4BB-4B360A-4K1M-4ZA.....	103	4BUB-4B630A-2/4K3M-4ZA.....	107
3BB-3B260A-2/3K2M-3ZA.....	101	48CAE52F2.....	54	48EAE52F2.....	41	4BB-4B360A-4K1MS-4Z1250A...105	105	4BUB-4B630A-2/4K3MS-F13.....	109
3BB-3B260A-3K2M-3VK2M.....	101	48CAE52S231.....	56	48EAE52S231.....	44	4BB-4B360A-4VK1M.....	103	4BUB-4B630A-4K3M-4VK3M.....	109
3BB-3B260A-3K2M-3WK2M.....	101	48CAE53F3.....	54	48EAE52S231.....	111	4BB-4B360A-4WK1M.....	103	4BUB-4B630A-4K3M-4VK4MS...109	109
3BB-3B260A-3K2M-3ZB.....	99	48CAE53H.....	53	48EAE53F3.....	41	4BB-4B460A-2/4K2M-4ZA.....	107	4BUB-4B630A-4K3M-4WK3M...107	107
3BB-3B260A-3VK2M.....	99	48CAE53S341.....	56	48EAE53H.....	40	4BB-4B460A-2/4K2MS-4Z1600A109	109	4BUB-4B630A-4K3M-4ZA.....	103
3BB-3B260A-3WK2M.....	99	48CAE58AM3.....	48	48EAE53S341.....	44	4BB-4B460A-4K2M-4VK2M.....	107	4BUB-4B630A-4K3MS-F13.....	105
3BTS-3B300A-2/3K2B-3ZB.....	83	48CAE58AM4.....	48	48EAE53S341.....	111	4BB-4B460A-4K2M-4WK2M.....	107	4BUB-4B630A-4VK3M.....	103
3BTS-3B300A-3K2B-3VK2B.....	83	48CAE75F3.....	54	48EAE58AM3.....	32	4BB-4B460A-4K2M-4ZA.....	103	4BUB-4B630A-4VK4MS.....	105
3BTS-3B300A-3K2B-3WK2B.....	83	48CAE75H.....	53	48EAE58AM4.....	32	4BB-4B460A-4K2MS-4Z1600A...105	105	4BUB-4B630A-4WK3M.....	103
3BTS-3B300A-3K2B-3ZB.....	81	48CAE75S341.....	56	48EAE58AM4.....	32	4BB-4B460A-4K2M-4ZA.....	103	4BUB-4B630A-4WK4MS.....	107
3BTS-3B300A-3VK2B.....	81	48CAE90AH4.....	48	48EAE74S341.....	111	4BB-4B460A-4VK2M.....	103	4BUB-4B630A-4K3M-4ZA.....	103
3BTS-3B300A-3WK2B.....	81	48CAE95S341.....	56	48EAE75F3.....	41	4BB-4B630A-2/4K3M-4ZA.....	107	4BUB-4B630A-4K3M-4VK3M...103	103
3BTSE-3B300A-3M2B-3ZB.....	69	48CCE30C1.....	58	48EAE75H.....	40	4BB-4B630A-2/4K3MS-F13.....	109	4BUB-4B630A-4K3M-4WK3M...103	103
3BTSE-3B300A-3VM2B.....	69	48CCE30C3.....	58	48EAE75S341.....	44	4BB-4B630A-4K3M-4VK3M.....	107	4BUB-4B630A-4K3M-4WK4MS...109	109
3BTSE-3B300A-3WM2B.....	69	48CPE125D4.....	50	48EAE90AH4.....	32	4BB-4B630A-4K3M-4WK3M.....	107	4BUB-4B630A-4K3M-4WK4MS...109	109
3BUB-3B180A-2/3K1M-3ZA.....	101	48CPE12D2.....	50	48EAE95S341.....	44	4BB-4B630A-4K3M-4WK4MS...109	109	4BUB-4B630A-4K3M-4WK4MS...109	109
3BUB-3B180A-3K1M-3VK1M.....	101	48CPE12Q.....	50	48EAE95S341.....	111	4BB-4B630A-4K3M-4ZA.....	103	4BUB-4B630A-4K3M-4WK4MS...109	109
3BUB-3B180A-3K1M-3WK1M.....	101	48CPE150D4.....	50	48ECE30C1.....	43	4BB-4B630A-4K3MS-F13.....	105	4BUB-4B630A-4K3M-4WK4MS...109	109
3BUB-3B180A-3K1M-3ZA.....	99	48CPE25D3.....	50	48ECE30C3.....	43	4BB-4B630A-4K3M-4WK4MS...109	109	4BUB-4B630A-4K3M-4WK4MS...109	109
3BUB-3B180A-3VK1M.....	99	48CPE25D3.....	50	48EPE1000D8.....	36	4BB-4B630A-4K3M-4WK4MS...109	109	4BUB-4B630A-4K3M-4WK4MS...109	109
3BUB-3B180A-3WK1M.....	99	48CPE36D3.....	50	48EPE125D4.....	36	4BB-4B630A-4K3M-4WK4MS...109	109	4BUB-4B630A-4K3M-4WK4MS...109	109
3BUB-3B180A-3WK1M.....	99	48CPE48D3.....	50	48EPE12Q.....	36	4BB-4B630A-4K3M-4WK4MS...109	109	4BUB-4B630A-4K3M-4WK4MS...109	109
3BUB-3B260A-2/3K2M-3ZA.....	101	48CPE65D4.....	50	48EPE12Q.....	36	4BB-4B630A-4K3M-4WK4MS...109	109	4BUB-4B630A-4K3M-4WK4MS...109	109
3BUB-3B260A-3K2M-3VK2M.....	101	48CPE90D4.....	50	48EPE150D4.....	36	4BB-4B630A-4K3M-4WK4MS...109	109	4BUB-4B630A-4K3M-4WK4MS...109	109
3BUB-3B260A-3K2M-3WK2M.....	101	48CSE1152ZB.....	52	48EPE200D6.....	36	4BB-4B630A-4K3M-4WK4MS...109	109	4BUB-4B630A-4K3M-4WK4MS...109	109
3BUB-3B260A-3K2M-3ZA.....	99	48CSE125D4.....	49	48EPE25D3.....	36	4BB-4B630A-4K3M-4WK4MS...109	109	4BUB-4B630A-4K3M-4WK4MS...109	109
3BUB-3B260A-3VK2M.....	99	48CSE12D2.....	49	48EPE36D3.....	36	4BB-4B630A-4K3M-4WK4MS...109	109	4BUB-4B630A-4K3M-4WK4MS...109	109
3BUB-3B260A-3WK2M.....	99	48CSE12Q.....	49	48EPE48D3.....	36	4BB-4B630A-4K3M-4WK4MS...109	109	4BUB-4B630A-4K3M-4WK4MS...109	109
3BUTS-3B300A-2/3K2B-3ZB.....	83	48CSE12ZA.....	52	48EPE50D6.....	36	4BB-4B630A-4K3M-4WK4MS...109	109	4BUB-4B630A-4K3M-4WK4MS...109	109
3BUTS-3B300A-3K2B-3VK2B.....	83	48CSE1502ZB.....	52	48EPE65D4.....	36	4BB-4B630A-4K3M-4WK4MS...109	109	4BUB-4B630A-4K3M-4WK4MS...109	109
3BUTS-3B300A-3K2B-3WK2B.....	83	48CSE150D4.....	49	48EPE90D4.....	36	4BB-4B630A-4K3M-4WK4MS...109	109	4BUB-4B630A-4K3M-4WK4MS...109	109
3BUTS-3B300A-3K2B-3ZB.....	81	48CSE1653ZB.....	52	48EPE90D4.....	36	4BB-4B630A-4K3M-4WK4MS...109	109	4BUB-4B630A-4K3M-4WK4MS...109	109
3BUTS-3B300A-3VK2B.....	81	48CSE2503ZB.....	52	48EPE90D4.....	36	4BB-4B630A-4K3M-4WK4MS...109	109	4BUB-4B630A-4K3M-4WK4MS...109	109
3BUTS-3B300A-3WK2B.....	81	48CSE25D3.....	49	48EPE90D4.....	36	4BB-4B630A-4K3M-4WK4MS...109	109	4BUB-4B630A-4K3M-4WK4MS...109	109
3BUTSE-3B300A-3M2B-3ZB.....	69	48CSE271ZB.....	52	48EPE90D4.....	36	4BB-4B630A-4K3M-4WK4MS...109	109	4BUB-4B630A-4K3M-4WK4MS...109	109
3BUTSE-3B300A-3VM2B.....	69	48CSE361ZB.....	52	48EPE90D4.....	36	4BB-4B630A-4K3M-4WK4MS...109	109	4BUB-4B630A-4K3M-4WK4MS...109	109
3BUTSE-3B300A-3WM2B.....	69	48CSE36D3.....	49	48CSE48D3.....	49	4BB-4B630A-4K3M-4WK4MS...109	109	4BUB-4B630A-4K3M-4WK4MS...109	109
47BAYS15AM3.....	28	48CSE48D3.....	49	48CSE50D6.....	36	4BB-4B630A-4K3M-4WK4MS...109	109	4BUB-4B630A-4K3M-4WK4MS...109	109
47BAYS21AM3.....	28	48CSE50D6.....	36	48EPE90D4.....	36	4BB-4B630A-4K3M-4WK4MS...109	109	4BUB-4B630A-4K3M-4WK4MS...109	109
47BAYS28AM3.....	28	48CSE50D6.....	36	48EPE90D4.....	36	4BB-4B630A-4K3M-4WK4MS...109	109	4BUB-4B630A-4K3M-4WK4MS...109	109
47BAYS35AM3.....	28	48CSE70Z2B.....	52	48EPE90D4.....	36	4BB-4B630A-4K3M-4WK4MS...109	109	4BUB-4B630A-4K3M-4WK4MS...109	109
47BAYS50AM3.....	28	48CSE80Z2B.....	52	48EPE90D4.....	36	4BB-4B630A-4K3M-4WK4MS...109	109	4BUB-4B630A-4K3M-4WK4MS...109	109
47BAYS70AH4.....	28	48CSE90D4.....	49	48EPE90D4.....	36	4BB-4B630A-4K3M-4WK4MS...109	109	4BUB-4B630A-4K3M-4WK4MS...109	109
47BAYS90AH4.....	28	48CTE20T2.....	55	48EPE90D4.....	36	4BB-4B630A-4K3M-4WK4MS...109	109	4BUB-4B630A-4K3M-4WK4MS...109	109
47BCYSB30C1.....	31	48CTE30T3.....	55	48EPE90D4.....	36	4BB-4B630A-4K3M-4WK4MS...109	109	4BUB-4B630A-4K3M-4WK4MS...109	109
47BCYSB30C3.....	31	48CTE40T4.....	55	48EPE90D4.....	36	4BB-4B630A-4K3M-4WK4MS...109	109	4BUB-4B630A-4K3M-4WK4MS...109	109
47BTYSB20T2.....	30	48EAE105AH4.....	32	48EPE90D4.....	36	4BB-4B630A-4K3M-4WK4MS...109	109	4BUB-4B630A-4K3M-4WK4MS...109	109
47BTYSB30T3.....	30	48EAE110F3.....	41	48EPE90D4.....	36	4BB-4B630A-4K3M-4WK4MS...109	109	4BUB-4B630A-4K3M-4WK4MS...109	109
47BTYSB40T4.....	30	48EAE110H.....	40	48EPE90D4.....	36	4BB-4B630A-4K3M-4WK4MS...109	109	4BUB-4B630A-4K3M-4WK4MS...109	109
48A17006.....	126	48EAE110S341.....	44	48EPE90D4.....	36	4BB-4B630A-4K3M-4WK4MS...109	109	4BUB-4B630A-4K3M-4WK4MS...109	109
48CAE105AH4.....	48	48EAE110S341.....	111	48EPE90D4.....	36	4BB-4B630A-4K3M-4WK4MS...109	109	4BUB-4B630A-4K3M-4WK4MS...109	109
48CAE110F3.....	54	48EAE110S341.....	111	48EPE90D4.....	36	4BB-4B630A-4K3M-4WK4MS...109	109	4BUB-4B630A-4K3M-4WK4MS...109	109
48CAE110H.....	53	48EAE135F4.....	41	48EPE90D4.....	36	4BB-4B630A-4K3M-4WK4MS...109	109	4BUB-4B630A-4K3M-4WK4MS...109	109
48CAE110S341.....	56	48EAE135H.....	40	48EPE90D4.....	36	4BB-4B630A-4K3M-4WK4MS...109	109	4BUB-4B630A-4K3M-4WK4MS...109	109
48CAE135F4.....	54	48EAE135MH4.....	32	48EPE90D4.....	36	4BB-4B630A-4K3M-4WK4MS...109	109	4BUB-4B630A-4K3M-4WK4MS...109	109
48CAE135H.....	53	48EAE135S461.....	44	48EPE90D4.....	36	4BB-4B630A-4K3M-4WK4MS...109	109	4BUB-4B630A-4K3M-4WK4MS...109	109
48CAE135MH4.....	48	48EAE135S461.....	111	48EPE90D4.....	36	4BB-4B630A-4K3M-4WK4MS...109	109	4BUB-4B630A-4K3M-4WK4MS...109	109
48CAE135S461.....	56	48EAE15AL3.....	32	48EPE90D4.....	36	4BB-4B630A-4K3M-4WK4MS...109	109	4BUB-4B630A-4K3M-4WK4MS...109	109
48CAE15AL3.....	48	48EAE175AX6.....	32	48EPE90D4.....	36	4BB-4B630A-4K3M-4WK4MS...109	109	4BUB-4B630A-4K3M-4WK4MS...109	109
48CAE175AX6.....	48	48EAE230AX6.....	32	48EPE90D4.....	36	4BB-4B630A-4K3M-4WK4MS...109	109	4BUB-4B630A-4K3M-4WK4MS...109	109
48CAE230AX6.....	48	48EAE230F4.....	41	48EPE90D4.....	36	4BB-4B630A-4K3M-4WK4MS...109	109	4BUB-4B630A-4K3M-4WK4MS...109	109
48CAE230F4.....	54	48EAE230H.....	40	48EPE90D4.....	36	4BB-4B630A-4K3M-4WK4MS...109	109	4BUB-4B630A-4K3M-4WK4MS...109	109
48CAE230H.....	53	48EAE230S461.....	44	48EPE90D4.....	36	4BB-4B630A-4K3M-4WK4MS...109	109	4BUB-4B630A-4K3M-4WK4MS...109	109
		48EAE230S461.....	111	48EPE90D4.....	36	4BB-4B630A-4K3M-4WK4MS...109	109	4BUB-4B630A-4K3M-4WK4MS...109	109

Model	Page	Model	Page	Model	Page	Model	Page	Model	Page
543446-7	124	67ES1670Z8	111	BL-2A	129	S112860-23-SG	117	SBA-12-AH	128
543490-10	112	67ES190D6	35	BL-4A	129	S112860-24-SG	117	SBA-18	128
543490-10	124	67ES190Z6	39	BL-6A	129	S112860-25-SG	117	SBA-18	128
544055-1M	121	67ES190Z6	111	BL-8A	129	S112860-26-SG	117	SBA-18-AH	128
544056-1M	121	67ES2060D8	35	BLL-6A	129	S112860-27-SG	117	SBA-18-AH	128
544163PT	123	67ES2060Z8	39	BLL-8A	129	S112860-28-SG	117	SBA-24-AH	128
544171PT	124	67ES2060Z8	111	BM-13A	129	S112860-29-SG	117	SBA-24-AH	128
544172PT	124	67ES285D6	35	BM-18A	129	S112860-30-SG	117	SBA-30-AH	128
544173PT	124	67ES285Z6	39	BM-25A	129	S112860-31-SG	117	SBA-30-AH	128
544174PT	124	67ES285Z6	111	BM-35A	129	S112860-32-SG	117	SBA-30-WM	128
544196-005	88	67ES385D6	35	BM-45A	129	S112861-01-SG	118	SBA-30-WM	128
544196-005	112	67ES385Z6	39	BML-13A	129	S112861-02-SG	118	TM-COM	119
544196-005	124	67ES385Z6	111	CSBA-12-AH	128	S112861-03-SG	118	TMEB-COM-V2.03	123
544196-020	88	67ES4050D12	35	CSBA-18-AH	128	S112861-04-SG	118	W08779K	125
544196-020	124	67ES475D6	35	CSBA-24	128	S112861-05-SG	118	W08780K	125
544196-050	88	67ES475Z6	39	CSBA-30	128	S112861-06-SG	118	W09164K	125
544196-050	124	67ES475Z6	111	CSBA-30-AH	128	S112861-07-SG	118		
544196-100	124	67ES610D6	35	CSBA18	128	S112861-08-SG	118		
544196-200	88	67ES610Z6	39	EMT1200-2R8-1"-APM	110	S112861-09-SG	118		
544196-200	124	67ES610Z6	111	EMT600-2-OS600-1"-APM	110	S112861-10-SG	118		
544196-250	124	67ES65BZ4	39	EMT600-2R6-1"-APM	110	S112861-11-SG	118		
544196-500	88	67ES65BZ4	111	EMT800-2-OS800-1"-APM	110	S112861-12-SG	118		
544196-500	124	67ES65D4	35	EMT800-2R6-1"-APM	110	S112861-13-SG	118		
544197PT	124	67ES850D8	35	MPRO400GC-E	115	S112861-14-SG	118		
544211PT	124	67ES850Z8	39	MPRO400GC-I	115	S112861-15-SG	118		
544237-1M	124	67ES850Z8	111	MPRO400GC-M	88	S112861-16-SG	118		
544238-1M	124	922325PT	113	MPRO400GC-M	114	S112861-17-SG	118		
544241PT	124	936400PT	123	MPRO400GC-P	88	S112861-18-SG	118		
544242PT	124	936491PT	123	MPRO400GC-P	114	S112861-19-SG	118		
544249PT	123	936492PT	123	MPRO400GC-S	114	S112861-20-SG	118		
579900PT-1000	89	960430-020	112	MPRO400GC-SG	88	S112861-21-SG	118		
579900PT-200	89	960431-020	112	MPRO400GC-SG	114	S112861-22-SG	118		
579900PT-23	89	960432-020	112	MPRO400GCMPCBCPS3A	89	S112861-23-SG	118		
579900PT-500	89	960433-020	112	MPRO400GCMPCBCPS3T	89	S112861-24-SG	118		
579900PT-68	89	960960-020	112	MPRO400GCMPCBCPS6A	89	S112861-25-SG	118		
67EA1035AH8	33	960961-020	112	MPRO400GCMPCBCPS6T	89	S112861-26-SG	118		
67EA1340AH8	33	961104-005	88	MPRO400GCMPCBCPS9A	89	S112861-27-SG	118		
67EA150S461	44	961104-005	88	MPRO400GCMPCBCPS9T	89	S112861-28-SG	118		
67EA150S461	111	961104-010	88	mProRemote	119	S112861-29-SG	118		
67EA1700AH8	33	961104-010	88	PDB-CPS3	89	S112861-30-SG	118		
67EA185S461	44	961104-020	88	PDB-CPS6	89	S112861-31-SG	118		
67EA185S461	111	961104-020	88	PDB-CPS9	89	S112861-32-SG	118		
67EA2010AH8	33	961104-030	88	PL-12A	129	S112870-SG	116		
67EA210S461	44	961104-040	88	S112849-SG	116	S112871-SG	116		
67EA210S461	111	961104-050	88	S112850-SG	116	S133405	124		
67EA235AL6	33	961104-060	88	S112860-01-SG	117	S133406	124		
67EA235S461	44	961104-070	88	S112860-02-SG	117	S133410	124		
67EA235S461	111	961104-080	88	S112860-03-SG	117	S133411	124		
67EA255AL6	33	961104-090	88	S112860-04-SG	117	S133420	124		
67EA255S461	44	961104-100	88	S112860-05-SG	117	S133436	124		
67EA255S461	111	961104-150	88	S112860-06-SG	117	S133437	124		
67EA310ML6	33	961104-200	88	S112860-07-SG	117	S308434	113		
67EA340AM6	33	961104-300	88	S112860-08-SG	117	S308435	113		
67EA460AM6	33	961104-400	88	S112860-09-SG	117	S308436	113		
67EA570AM6†	33	961104-500	88	S112860-10-SG	117	S308437	113		
67EA860AH8	33	961249-010	122	S112860-11-SG	117	S308438	113		
67ES1050D8	35	961250-010	122	S112860-12-SG	117	S308439	113		
67ES1050Z8	39	961251-010	122	S112860-13-SG	117	S308440	113		
67ES1050Z8	111	961252-010	122	S112860-14-SG	117	S308441	113		
67ES105BZ4	39	961259-010	122	S112860-15-SG	117	S308450	113		
67ES105BZ4	111	961299-005	88	S112860-16-SG	117	S308474	113		
67ES105D4	35	961299-010	88	S112860-17-SG	117	S308475	113		
67ES135BZ4	39	961299-020	88	S112860-18-SG	117	S970716	124		
67ES135BZ4	111	961341-***	123	S112860-19-SG	117	S976956	113		
67ES135D4	35	961342-***	123	S112860-20-SG	117	SBA-12	128		
67ES1670D8	35	961350PT	123	S112860-21-SG	117	SBA-12	128		
67ES1670Z8	39	961453PT	123	S112860-22-SG	117	SBA-12-AH	128		

Warranty

Apex Tool Group, LLC warrants products and parts sold by it, insofar as they are of its own manufacture, against defects of material and workmanship, under normal use and service in accordance with its written instructions, recommendations, and ratings for installation, operation, maintenance, and service of products, for a period of **ONE YEAR FROM THE DATE OF INITIAL USE, BUT IN NO EVENT SHALL THE WARRANTY EXCEED 24 MONTHS FROM DATE OF DELIVERY TO DISTRIBUTOR.** Proof of Purchase with shipment date must be furnished by the user to validate the warranty. This warranty applies only to products manufactured by Apex Tool Group and specifically excludes products manufactured by others. Products not manufactured by Apex Tool Group are warranted only to the extent and in the manner warranted to Apex Tool Group by the manufacturer

and then only to the extent Apex Tool Group is able to enforce such warranty. Apex Tool Group's warranty with respect to products manufactured by it is limited to the repair or replacement, as Apex Tool Group may elect, of any defective part regarding which the Distributor has given 5 days written notice from the discovery of such defect. Installation and transportation costs are not included. Apex Tool Group shall have the option of requiring the return to it of the defective material, transportation prepaid, for inspection. No allowance will be made for repairs without Apex Tool Group approval. **APEX TOOL GROUP MAKES NO OTHER WARRANTY OF ANY KIND WHATSOEVER, EXPRESSED OR IMPLIED, AND HEREBY DISCLAIMS ALL WARRANTIES OF MERCHANTABILITY AND FITNESS FOR A PARTICULAR PURPOSE.**

Lubrication Products

Apex Tool Group products are classified as non-hazardous manufactured items, defined in the OSHA 1910.1200 Hazard Communication Standard as "Articles". These products, under conditions of normal use, do not release or cause exposure to a hazardous chemical.

Under normal conditions of use, lubrication products sold separately for or used within these tools should not cause an exposure hazard. Refer to the Material Safety Data Sheet (M.S.D.S.) for Safety and Disposal Information. M.S.D.S. sheets are available upon request from Apex Tool Group.

Apex Tool Group is also aware of, and complies with, the provisions of section 611 amendments

to the Clean Air Act of 1990. No ozone depleting chemicals have been used in the manufacture of our products.

If you resell or distribute these products, you have the responsibility for ensuring that the Material Safety Data Sheets are provided to the purchaser.

Proper lubrication is essential to the economical operation of pneumatic and electric tools. Apex Tool Group perform better and their life is extended by using the recommended lubricants. All lubricants that are listed in the accessory section of this catalog have undergone extensive testing and are recommended for use with Apex Tool Group products.

Fastener Selection

The suggested fasteners listed in this catalog are determined by matching a tool's maximum rated load to Society of Automotive Engineers (SAE) Grade 5 and International Organization of Standardization (ISO) Grade 9.8 fasteners. The torque capabilities for SAE Grade 5 fasteners are from SAE Manual, SAE J429 (Mechanical and Material Requirement for Externally Threaded Fasteners). The torque capabilities for ISO Grade 9.8 fasteners are from ISO 898-1 (Mechanical Properties of Fasteners). All values selected are based on lubricated fasteners.

The suggested fasteners listed in this catalog are advisory only, and Apex Tool Group recommends that you further consult other technical references before final tool selection. Reliance on the accuracy of this catalog data for any purpose by anyone is at the sole risk of that person. Apex Tool Group is not responsible for any loss, claim, or damage arising from improper tool selection.

The torque values listed under the headings "TORQUE" are tested on an ISO 5393 soft joint rate test fixture unless otherwise stated by a special note.

Para mayor información técnica y consulta de nuestros productos póngase en contacto con nuestros asesores de Coirmex, S.A. de C.V., visite nuestro sitio web en www.coirmex.com.

Coirmex, S.A. de C.V.
Casma 551 Col. Lindavista
C.P. 07300 México, D.F.
Tel: +52(55) 5752-9784
+52(55) 5752-9764
www.coirmex.com